

## LED light fixtures from Hangzhou Hemos

### HANGZHOU HEMOS LIGHTING COMPANY LIMITED

8F/A-3 New Life Of West, NO.98 GuDun Road, Hangzhou, Zhejiang, China(zip:310013)

tel: +86-571-28029150 fax: +86-571-28029153 E-mail: ma@ioucys.com

[WWW.IOUCYS.COM](http://WWW.IOUCYS.COM)



**IN** Spring 1992 near West Lake and Zhejiang University we started our journey. It felt amazing when we shipped out our first cargo of incandescent bulb twenty years ago. The feeling stayed unchanged from that time on.

What has changed is technology. From Halogen to CFL to LED, innovation ascends at the speed of lightning. With great effort, we have ascended with it. Today, we have our own Research & Design team and manufacturing factories. Our offer to you is the best lighting appliance made in China with superior quality , considerate service and competitive price.

We look forward to hear from you of this enterprise we love.

Hangzhou Hemos Lighting Company Limited

# Indoor Lighting

---

IOUCYS.COM



## Panel Light LED

## LARKIN

All sides are lined with LED's to grant optimal illumination.  
 High light output at a reduced energy consumption of up to 50%.  
 Over 40000 hours life expectancy.Wide angle of deflection with even light distribution.  
 No start-up delay,no flickering,no humming.  
 High efficiency(95%) constant current driver with built-in overheat protection that remains stable at a wide range of input voltages.  
 Independent LED circuit design prevents complete blackout in case an LED fails.  
 Causes no electromagnetic interference.  
 Operating Temperature: -20°C to +40°C  
 Humidity Operating: 10-80%,  
 Product weight:6.1kg

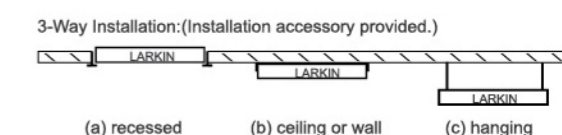
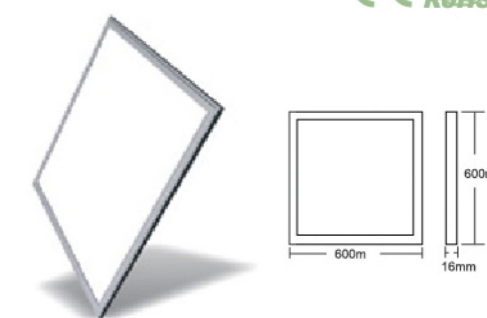

## Square Touch Interface Controller

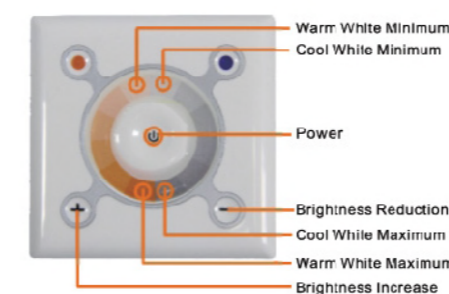

Used for Color Temperature&Brightness control for dimmable LED Lights.Direct setting of each warm white and cool white independently.

Input voltage:DC24V;  
 Output channel:2 channel,  
 Output current:2A,  
 Output type:common anode.

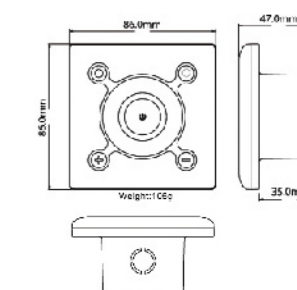

## LED Mini Remote Controller



Used for Brightness control for the LED lights.It can change brightness.Power-loss memory recovery function,adjust brightness.  
 Max working distance:20 meters.

## Electrical connection

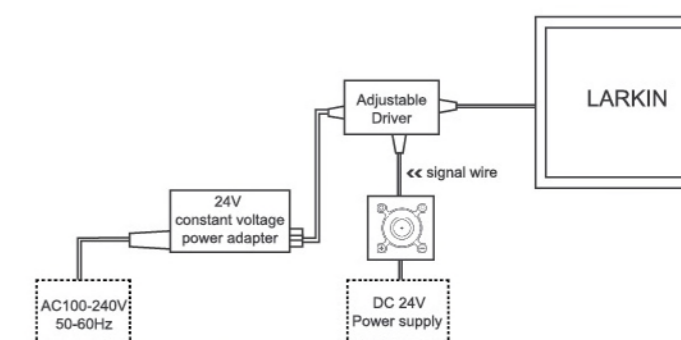

Code	Model	Voltage	Rated Power	CCT	CRI	lumen	Dimmable
io-204001	LK-38	100-240V	38W	4000K	80	3000lm	No
io-204002	LK-45	100-240V	45W	4000K	80	3600lm	No
io-204003	LKD-W	100-240V	0-40W	4000K	80	3000lm	Brightness
io-204004	LARKIN	100-240V	0-58W	3000-6000K	80	0-4500lm	CCT&Brightness



## Louvre Light T8 LED Tube

High quality steel painted by UV-proof powder body with color white,highly polished aluminum parabolic louvre.IP20 for degree of protection.  
220V-240V/50Hz of rated voatage.Option for materials of reflector.Option for I type grid or V type grid .Electronic/magnetic ballast,possibility of installation emergency electro inventer,or dimmable ballast.  
IP20

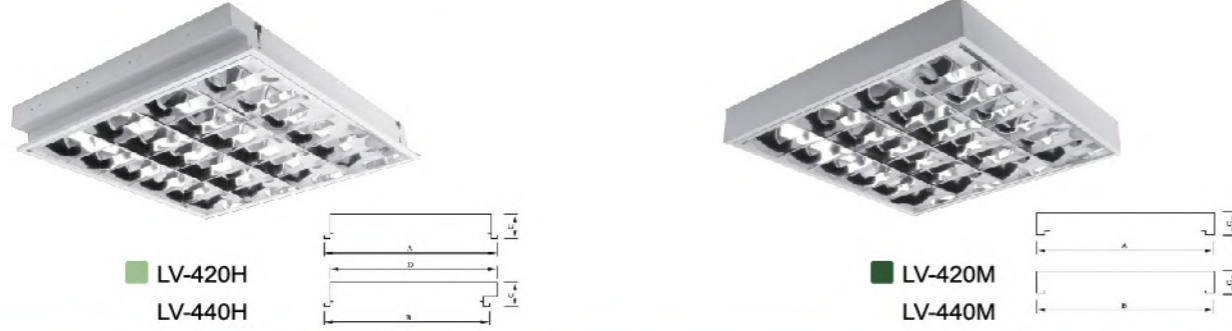

Code	Model	Circuit Wattage	Grid spacing W×L(mm)	A×B×C (mm)	D (mm)	Code	Model	Circuit Wattage	Grid spacing W×L(mm)	A×B×C (mm)
io-205006	LV-420H	4×9W	600×600	595×595×80	610	io-205008	LV-420M	4×9W	600×620	600×620×80
io-205007	LV-440H	4×18W	600×1200	595×1195×80	1220	io-205009	LV-440M	4×18W	600×1230	600×1230×80

## Louvre Light T5 LED Tube

High quality steel painted by UV-proof powder body with color white,highly polished aluminum parabolic louvre.IP20 for degree of protection.  
220V-240V/50Hz of rated voatage.Option for materials of reflector.Option for I type grid or V type grid .Electronic/magnetic ballast,possibility of installation emergency electro inventer,or dimmable ballast.  
IP20

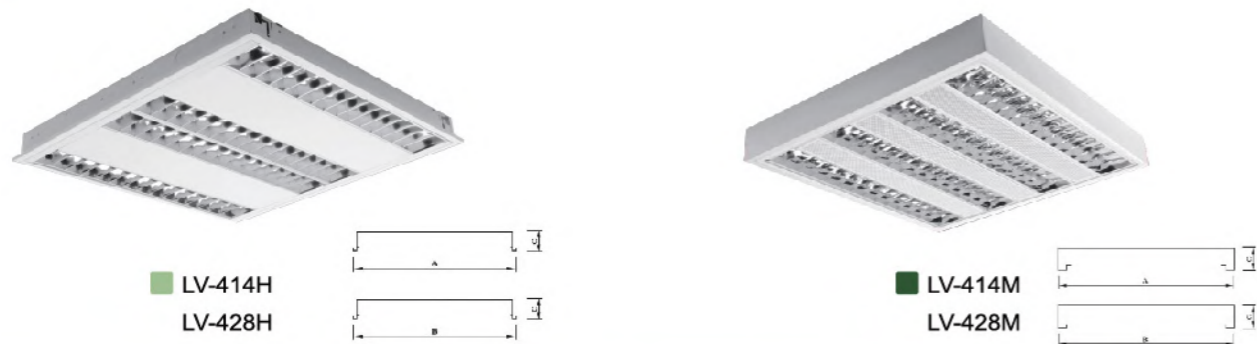

Code	Model	Circuit Wattage	Grid spacing W×L(mm)	A×B×C (mm)	Code	Model	Circuit Wattage	Grid spacing W×L(mm)	A×B×C (mm)
io-205010	LV-414H	4×6W	600×600	595×595×52	io-205012	LV-414M	4×6W	600×600	595×595×60
io-205011	LV-428H	4×18W	600×1500	595×1195×52	io-205013	LV-428M	4×18W	600×1200	595×1195×60

## Cabinet Light T5 LED

Think

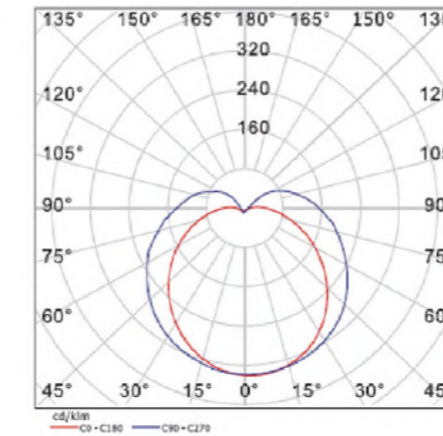

**NO Dark Area:**  
Using high quality SMD LED chips, it's integrated design without dark areas that create the unique appearance.

**High Efficiency:**  
The entire high efficiency reach up to 85lm/W , 50% energy was saved compared with ordinary fixture.

**Safe and Reliable:**  
Built –in wide voltage (AC85-265V) constant direct current drive, it complies with UL, CE, CQC safety regulations .useful service up to 35000 hours.

**Environmental:**  
The LED complies with EU ROHS , and non-traditional fluorescent mercury pollution and ultraviolet ,also energy saving and low carbon

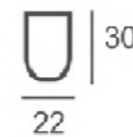

Code	Power(W)	PF	Luminous Flux(km)	CCT(K)	CRI(Ra)	Lifetime(h)	Dimension(mm)	Beam Angle(°)
io-204005	4	≥0.9	350-380	3000/4000/6500	80	35000	313x22x30	120
io-204006	6	≥0.9	520-580	3000/4000/6500	80	35000	543x22x30	120
io-204007	8	≥0.9	620-650	3000/4000/6500	80	35000	573x22x30	120
io-204008	10	≥0.9	880-920	3000/4000/6500	80	35000	873x22x30	120
io-204009	14	≥0.9	1150-1300	3000/4000/6500	80	35000	1173x22x30	120
io-204010	18	≥0.9	1440-1650	3000/4000/6500	80	35000	1473x22x30	120

## LED downlight

**6"**  
Plastic coated aluminium profile for good heat dissipation. Thermal conductive plastic housing make sure safe light. v-0 flame rating.  
Triac dimmable version for option.  
Working Temperature:-20°C~40°C  
Driver built-in  
Warrenty:3years.  
Dimension: Ø174\*78.5mm.  
Package information:Ctn size73.5\*37\*44.5cm g.w. 16.5kgs/ctn.

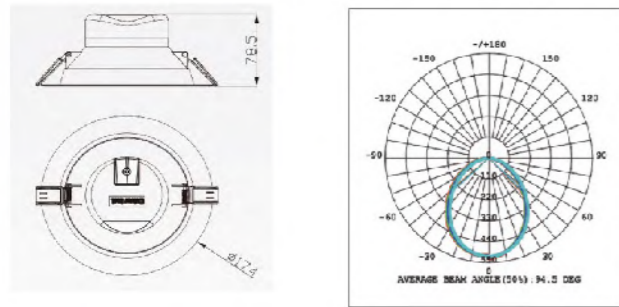

### Sydney



replace Classic version 2\*18W pl



IP44 90° 110/220 VAC



**8"**  
Anodizing aluminium which is elegant and stylish. non-isolated driver build-in. High lumen efficiency of 95lm/W. Working Temperature:-20°C~40°C Warrenty:3years.  
Dimension: Ø232\*100mm.  
Package information:Ctn size61.5\*52.5\*51cm g.w. 19kgs/ctn.

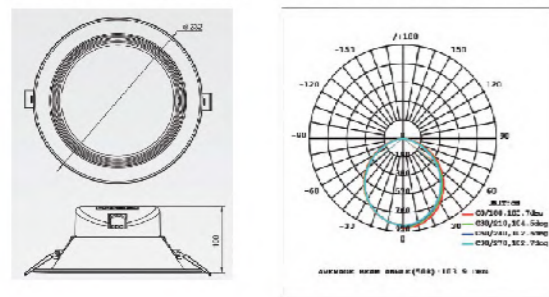

replace Classic version 2\*26W pl



IP44 90° 110/220 VAC

Code	Model	Voltage	LED Power	Ra	Lumen	Beam Angle	Cutout(mm)	Life
io- 204016	sydney-6	230V	14W	>80	1200	90°	Ø145-155	30000
io- 204017	sydney-6	230V	17W	>80	1500	90°	Ø145-155	30000
io-204018	sydney-8	230V	20W	>80	1800	90°	Ø195-210	30000
io- 204019	sydney-8	230V	25W	>80	2350	90°	Ø195-210	30000

## LED downlight Eye

Photobiological safety  
Environmental Temperature:-20°C~60°C  
Environmental Humidity:0%~95%  
Material:Aluminium  
Driver:Exterior incl.  
Pcs/Carton:30  
Carton Dimensions(cm):47\*33.5\*18.5  
20'/40'/40 HQ pcs:28980/58980/68970



eye-fix

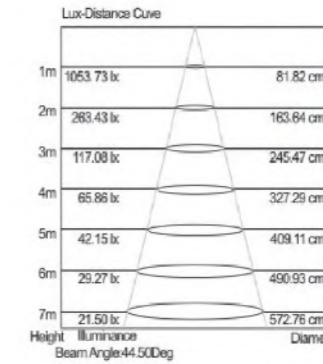
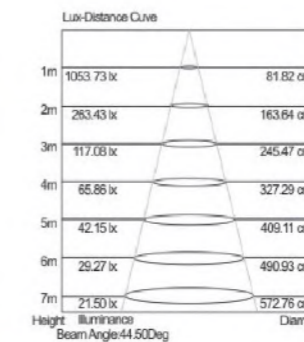

eye-adj

Environmental Temperature:-20°C~60°C  
Environmental Humidity:0%~95%  
Material:Aluminium  
Driver:Exterior incl.  
Pcs/Carton:30  
Carton Dimensions(cm):47\*33.5\*18.5  
20'/40'/40 HQ pcs:28980/58980/68970

Description:  
It adopts high brightness high quality LED as luminous body with low -voltage constant current driver, low power consumption, long lifespan, reliability and safety. The special injection-molded technique is adopted in the housing with high thermally conductive plastics and coated aluminum. Good thermal management ensures stable working of LED, and controls light attenuation effectively.  
This product is widely used in shopping mall, hotel, restaurant and etc.

Environmental Humidity:0%~95%  
Material:Aluminium  
Driver:included.  
Dimensions(cm):8.5\*7.7\*7.4

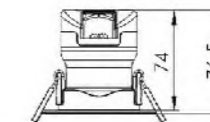
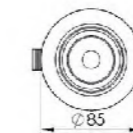

### Melbour



Code	Model	Voltage	LED Power	Ra	Size	Lumen	Beam Angle	Cutout(mm)	Dimmable
io- 204011	melbour	220-240V	7W	>80	Ø85*H76.5	580	36°	Ø68-75	no
io- 204012	eye-adj	220-240V	9W	>80	Ø85*H42	600	38°	Ø75	no
io-204013	eye-adj	220-240V	9W	>80	Ø85*H42	600	38°	Ø75	yes
io- 204014	eye-fix	220-240V	9W	>80	Ø85*H65	500	25°	Ø75	no
io- 204015	eye-fix	220-240V	9W	>80	Ø85*H65	500	25°	Ø75	yes

## BISHOP

**LED**

Lamps can be chromatic too. Apart from the usual emitting of light, they sometimes can be a colorful light themselves. This series of lamps is available in many colors - There must be a right one for the occasion.



■ BS-1

■ BS-2

## WORDSWORTH



■ WW-1



■ WW-2

when the art of ceramics and the technique of weaving combine, the result is simply brilliant. These two designs can be on a table one hundred years ago and look smart. Today, they are just as good as always.

Code	Model	Voltage	LED Power	Lumen	CCT	Product Dimension(mm)		
						Base	Body	Head
io-301008	BS-1	AC110-240V	3.2W	240	4000K	clip	H300	Φ60
io-301009	BS-2	AC110-240V	3.2W	240	4000K	Φ100	H360	Φ60

Code	Model	Voltage	Max Watt	Lamp Holder	CCT	Product Dimension(mm)		
						Base	Body	Shade
io-302001	WW-1	AC110-240V	60W	E27	4000K	Φ100	H350	Φ230
io-302002	WW-2	AC110-240V	40W	E14	4000K	Φ110	H230	Φ200

## Table Lamp & Floor Lamp

All of us love Pixar's great animated films. The same, almost, goes with the iconic Pixar lamp. these four designs seek to capture all the playfulness and joy that a lamp has to offer.



Frost

Heine

Hugo



Baudelaire



Rilke

Keats

Rossetti

The usual floor lamps distract people from the room that they guard. Our lineup, on the contrary, tries to complete the space with its minimalistic design - no extravagance.

Code	Model	Voltage	Max Watt	Lamp Holder	Product Dimension(mm)		
					Base	Body	Head
io-302003	Baudelaire	AC110-240V	60W	E27/E14	Φ165	H600	Φ115
io-302004	Frost	AC110-240V	60W	E27/E14	Φ165	H550	Φ128
io-302005	Heine	AC110-240V	40W	E14	Φ120	H400	Φ120
io-302006	Hugo	AC110-240V	40W	E14	Φ120	H350	Φ100
io-302007	Rilke	AC110-240V	60W	E14	Φ180	H1400	Φ85
io-302008	Keats	AC110-240V	60W	E27	Φ200	H1810	Φ155
io-302009	Rossetti I	AC110-240V	60W	E27	Φ200	H1800	Φ220
io-302010	Rossetti II	AC110-240V	60W+40W	E27+E14	Φ200	H1800	Φ220+Φ100



## IP20/IP44 LED Wall Ceiling Lamp



### Application

Kitchens, balconies, hallways, offices, stores, hospitals, schools, lobbies and supermarkets etc.

### Product Information

Energy-efficient, able to save 65% more energy than ordinary illuminators.

Healthy and Eco-Friendly: no hazardous substances like mercury or lead, etc., pollution-free to environment, no infrared or ultraviolet radiation, no harm to human body.

Ultra-longer service life: semiconductor chips lighten, no filament or glass bulb, non breakable, service life more than 30,000 hours.

Dc and constant-current driving are adopted, so that light is distributed in uniformity, no RF interference, stable and reliable, power factor=0.5 Quick response time. It is a high-speed-response lamp.

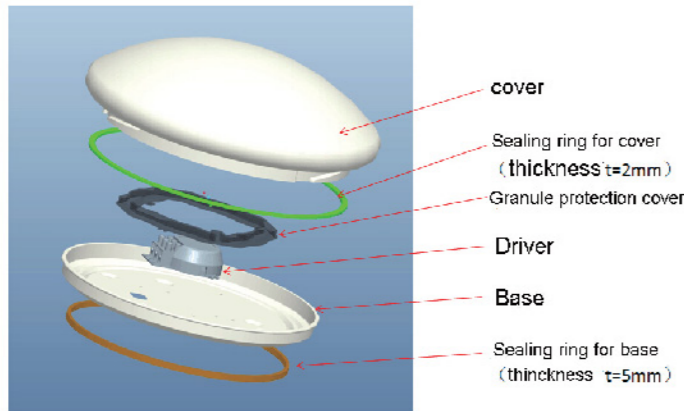

IP44 explosive view



## Outdoor Lighting

Code	Model	Wattage	Volt	CRI	Lumen(3000K)	Lumen(6500K)	PF	Dimension	Lifetime
io-204020	HE03-06	6W	220-240V	>80	350lm	400lm	0.5	Φ175*80	25000h
io-204021	HE03-12	12W	220-240V	>80	720lm	800lm	0.5	Φ250*80	25000h
io-204022	HE03-18	18W	220-240V	>80	1050lm	1300lm	0.5	Φ250*80	25000h
io-204023	HE03-24	24W	220-240V	>80	1450lm	1700lm	0.5	Φ320*95	25000h



## Wall&Ceiling Light

Base and frame: nylon reinforced fiberglass.  
With silicon gasket at a waterproof IP55

Reflector: pressed aluminum.  
Diffuser: opal polycarbonate.  
Wiring: included 100V-240V 50Hz power supply, fasten connector.  
Double insulated.  
Application: ceiling&wall,both indoor and outdoor use.  
Color:white,black,grey

## Walt



LED

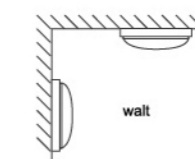

## walt.w

LED



Base and frame: polycarbonate.fix with pitch  
Waterproof IP44  
Diffuser: opal polycarbonate.  
Install bulb: E27 CFL or 2D fluorescent tube.  
Application: ceiling, both indoor and outdoor use.  
Color:white,silver,golden

Code	Model	Input Voltage	Bulb	Power	Lumen	Color Temperature	Product Dimension(mm)
io-105001	walt	100-240V AC	LED	12w	900	4000k	D295H90
io-105002	walt	100-240V AC	CFL	20W	1000	2700K/4000K	D295H90
io-105003	walt.w	100-240V AC	CFL	2X20W	2000	2700K/4000K	D325H100
io-105004	walt.w	100-240V AC	2D	28W	2000	2700K/6400K	D325H100
io-105005	walt.w	100-240V AC	LED	20w	1800	2700K/6400K	D360H100

## IP54 LED Wall Ceiling Lamp



### Sensor Version

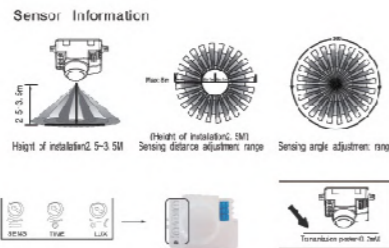
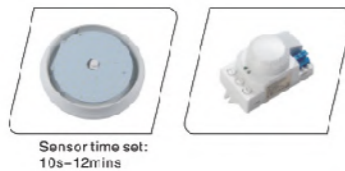

### Application

Kitchens, balconies, hallways, offices, stores, hospitals, schools, lobbies and supermarkets etc.

### Product Information

Energy-efficient, able to save 65% more energy than ordinary illuminators.

Healthy and Eco-Friendly: no hazardous substances like mercury or lead, etc., pollution-free to environment, no infrared or ultraviolet radiation, no harm to human body.

Ultra-longer service life: semiconductor chips lighten, no filament or glass bulb, non breakable, service life more than 30,000 hours.

Dc and constant-current driving are adopted, so that light is distributed in uniformity, no RF interference, stable and reliable, power factor=0.9 Quick response time. It is a high-speed-response lamp.

Detection angle: 360°  
Detection range: 1-8m (radii.) (adjustable)  
Time setting: 10sec. to 12min.  
Light-control: 10~2000Lux  
Standby power: approx. 0.9W  
Working temperature: -15°C~70°C  
HF system: 5.8GHz

### Emergency Version

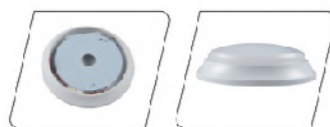

Emergency incharge time: 24 hours  
Emergency battery time: 1-3hours  
Emergency situ on power output: 2W

Code	Model	Wattage	Volt	Ra	Lumen	PF	Size(mm)	Qty/ctn	Packaging size(mm)
io-105006	HE09A-300-14	14W	100-240V	>80	1150lm	0.9	305*84	8pcs	720x330x335
io-105007	HE09A-300-17	17W	100-240V	>80	1450lm	0.9	305*84	8pcs	720x330x335
io-105008	HE09A-400-21	21W	100-240V	>80	1800lm	0.9	400*96	8pcs	615x430x435
io-105009	HE09A-400-28	28W	100-240V	>80	2400lm	0.9	400*96	8pcs	615x430x435

## LED Water Proof Fixture



### T8-C-LED



#### Basic Accessories

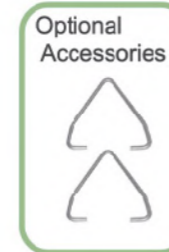

### Specifications

- Cover Material: high impact resistant polycarbonate with light diffusing agent
- Fixture Housing: polycarbonate
- Light Source:
  - high quality LED chips
  - new energy, long life,
  - low-carbon, low heat, energy-saving, eco-friendly, mercury-free
  - safe voltage : less than 36V DC, there is no risk of electric shock;
  - 25°C ambient temperature under L70 lumen Time:> 30K hours;
  - Color Temperature: 4000-6500K;
- Protection class IP65
- Class II Appliance
- Life of the drive: two years

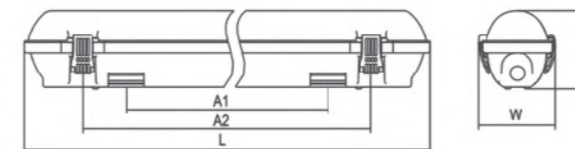

Input Voltage: 220-240V 50/60Hz CCT:4000-6500k

Code	Model	Wattage	LED	LED quantity	Lumen	CRI	Range	Length	Width	Height	A1	A2	Clips
io-105010	HE118C	11.5W	SMD2835	56	1150lm	>80	T8-18W*1	655	89	92	420	530	6
io-105011	HE136C	23W	SMD2835	119	2300lm	>80	T8-36W*1	1265	89	92	900	1010	10
io-105012	HE158C	30W	SMD2835	154	3000lm	>80	T8-58W*1	1565	89	92	1000	1110	12
io-105013	HE218C	23W	SMD2835	112	2300lm	>80	T8-18W*2	655	130	92	420	530	6
io-105014	HE236C	48W	SMD2835	238	4800lm	>80	T8-36W*2	1265	130	92	900	1010	10
io-105015	HE258C	58W	SMD2835	308	5800lm	>80	T8-58W*2	1565	130	92	1000	1110	12

### Damp-Proof Light T8 Fluorescent Tube

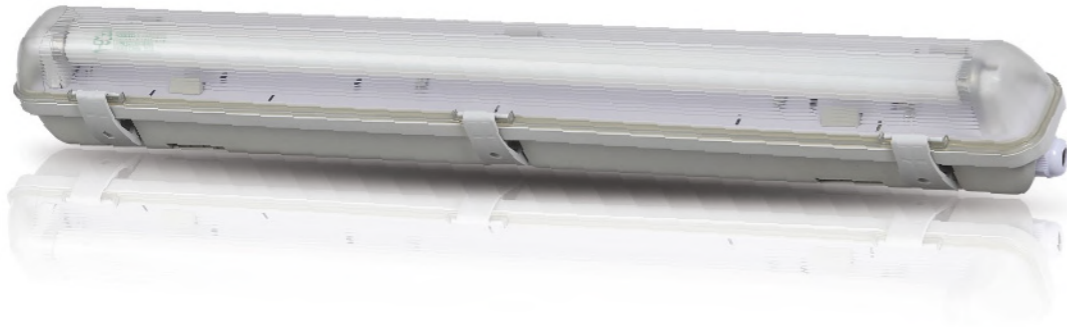

Dust Proof and Water Proof  
Durable outer Casing/Cover made of High Impact ABS or PC materials  
European Certification  
Indoor or outdoor installation in the garages, cellars and industrial complex  
Available with Electric Ballast and Lamp Tube  
Shipped on pallets

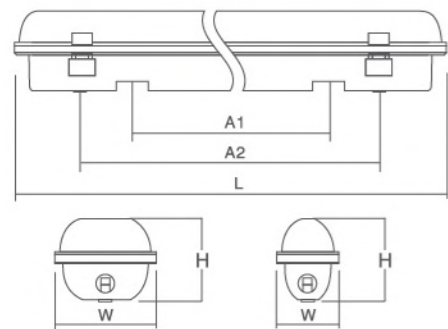

Outer Casing: ABS or PC materials  
Cover: Clear PS, PMMA or PC Materials  
Metal Plate: chemical treated and powder coated  
Locks: ABS, PC or Stainless Clips  
Cable Seal: 5 pieces cable entry seal  
Safety Class: Class I  
Standard Compliance: EN 60598-1, EN60598-2-1, EN 55015, EN 61000-3-2, EN 61000-3-3, EN 61547  
Certification: GS,CE, EMC,RoHS

Code	Model	Length	Width	Height	A1	A2	Clips	Max.Watt	IP Rating
io-105016	DP118A	650	72	86	420	530	6	1*18W	IP65
io-105017	DP218A	650	115	86	420	530	6	2*18W	IP65
io-105018	DP136A	1265	72	86	900	1010	10	1*36W	IP65
io-105019	DP236A	1265	115	86	900	1010	10	2*36W	IP65
io-105020	DP158A	1565	72	86	1000	1110	12	1*58W	IP65
io-105021	DP258A	1565	115	86	1000	1110	12	2*58W	IP65

### Damp-Proof Light T8 LED Tube



Dust Proof and Water Proof  
Durable outer Casing/Cover made of High Impact ABS or PC materials  
European Certification  
Indoor or outdoor installation in the garages, cellars and industrial complex  
Available with LED Tube  
Shipped on pallets

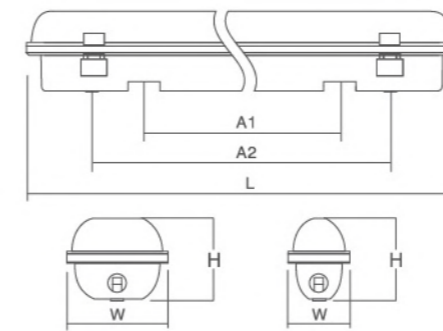

Outer Casing: ABS or PC materials  
Cover: Clear PS, PMMA or PC Materials  
Metal Plate: chemical treated and powder coated  
Locks: ABS, PC or Stainless Clips  
Cable Seal: 5 pieces cable entry seal  
Safety Class: Class I  
Certification: GS,CE, EMC,RoHS

Code	Model	LED Power	Lumen	Lenght	width	Height	A1	A2	Clips	IP Rating
io-104001	HE118A	1*9W	850lm	650	72	86	420	530	6	IP65
io-104002	HE118A	2*9W	1700lm	650	115	86	420	530	6	IP65
io-104003	HE118A	1*18W	1800lm	1265	72	86	900	1010	10	IP65
io-104004	HE118A	2*18W	3600lm	1265	115	86	900	1010	10	IP65
io-104005	HE118A	1*24W	2400lm	1565	72	86	1000	1110	12	IP65
io-104006	HE118A	2*24W	4800lm	1565	115	86	1000	1110	12	IP65

## Flood Light LED

### Norma

Input Voltage: 220V-240V ~ 50/60Hz  
Color Rendering Index(Ra): > 65  
LED Color Temperature(CCT):3000K/4000K/6500K  
Working Temperature:-40℃~40℃  
Life time: 25 000 hours

IP65  
Tempered glasses  
Aluminium die-casting body  
Color of body: black, grey



50W  
portable

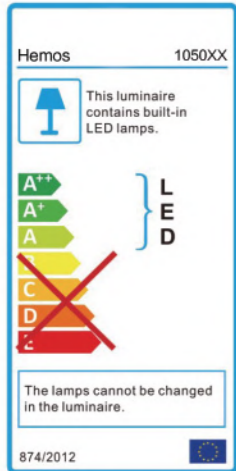

10W  
standard

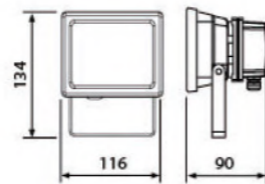

10W



30W  
standard

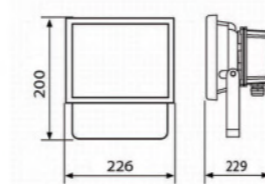

30W

Code	Model	LED Power	Lumen	Beam Angle	Packing Info.
io-105028	standard	10W	650lm	100°	20pcs,47.5*26.5*25.5cm,13kg
io-105029	standard	20W	1440lm	100°	6pcs,44*57.5*13cm,7.8kg
io-105030	standard	30W	2300lm	100°	6pcs,48.5*29.5*35cm,16kg
io-105031	standard	50W	3600lm	100°	4pcs,66.5*38.5*29.5cm,13.5kg
io-105032	portable	50W	3600lm	100°	2pcs,62*38*37.5cm,9.6kg

## Flood Light LED

### THIN

Input Voltage: 220-240V ~ 50/60Hz  
Color Rendering Index(Ra): >65  
LED Color Temperature(CCT):3000K/4000K/6500K  
Working Temperature:-40℃ ~ 40℃.  
Life time:25,000 hours

IP65 10W/20W/30W/50W standard  
Tempered glasses  
Aluminium die0casting body  
Color of body: black,grey,white  
Sensor seris with PIR 100°  
IP44 10W/20W/30W sensor

50W  
standard

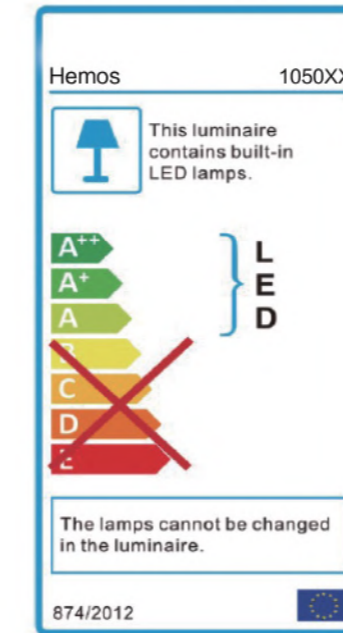

20W  
standard

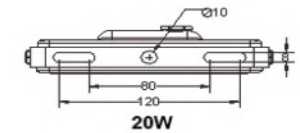

20W

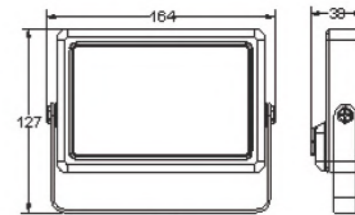

20W



10W  
sensor

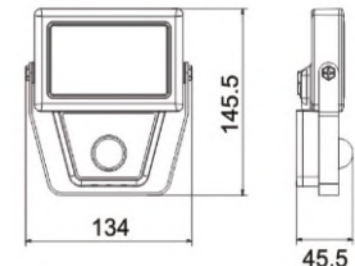

45.5

Code	Model	LED Power	Lumen	LED	Size(cm)	Packing info.
io-105033	standard	10W	650lm	18pcs 2835	13.4*10.5*3.8	16pcs,30.5*21*21cm,7.5kgs
io-105034	standard	20W	1300lm	36pcs 2835	16.4*12.7*3.8	16pcs,36.5*21*25.5cm,10.5kgs
io-105035	standard	30W	1950lm	54pcs 2835	19.4*15.1*3.8	12pcs,42.5*16*29.5cm,10kgs
io-105036	standard	50W	3250lm	90pcs 2835	27.8*20.0*4.5	9pcs,42.5*21.5*30.5cm,10kgs
io-105037	sensor	10W	650lm	18pcs 2835	13.4*14.5*4.5	16pcs,31*31*17.5cm,9.8kgs
io-105038	sensor	20W	1300lm	36pcs 2835	16.4*16.4*4.5	16pcs,37*35*16.5cm,12.5kgs
io-105039	sensor	30W	1950lm	54pcs 2835	19.4*18.4*4.5	12pcs,38*23*23cm,11.5kgs

## LED Floodlight

Color Rendering index(Ra):>65  
LED Color Temperature(CCT):  
2700-7000K available  
Tempered glasses  
Color of body: Available  
AC 110-240V,50/60Hz

### Material/Chips

LED Bridgelux

### Standards

CE, RoHS

### Guarantee

2 years from date of purchase

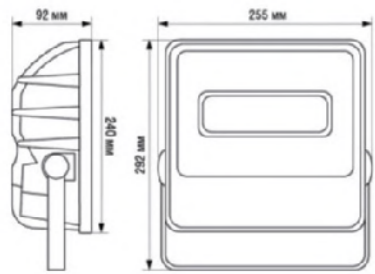

## MING



Asymmetric



Symmetrical

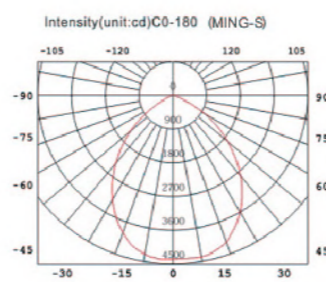
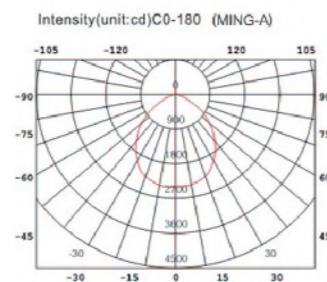

Code	Model	Voltage	Power Consumption	Qty/Ctn	Carton Size	Ra	IP class	Lumen
io-105040	M50	AC110-240V	50W	8pcs	56.0*45.5*22cm	65	65	3500
io-105041	M80	AC110-240V	80W	4pcs	47.5*26.5*26cm	65	65	5500
io-105042	M100	AC110-240V	100W	4pcs	47.5*26.5*26cm	65	65	7000
io-105043	M200	AC110-240V	200W	1pcs	51.0*40.5*21.5cm	65	65	14000
io-105044	M300	AC110-240V	300W	1pcs	56.0*48.2*20cm	65	65	22000

## Flood Light LED 30W 2100lm

Product Information:  
Color Rendering index(Ra):>65  
LED Color temperature(CCT):  
2700-7000K available  
Aluminium die-casting body  
Temperatures glasses  
Color of body: Available

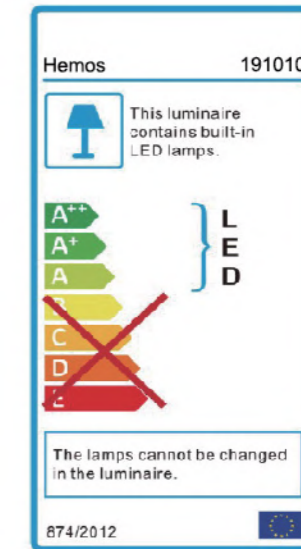

### Bluetooth speakers

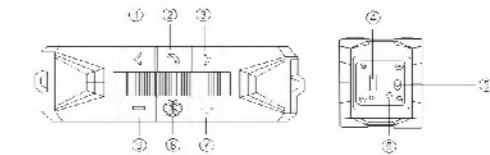

Description:  
Adopting the latest boosting technology for power amplifier IC, to gain brighter treble more full-bodied tenor, and more passionate bass.

Key Features  
interface:AUX,mirco-USB,2.0 USB  
bluetooth connection distance:about 10meters  
Function button  
1. skip back  
2. Answer-End Call  
3. skip track  
4. 2.0 usb  
5. on/off  
6. AUX  
7. volume up  
8. long press to enable "paring" status pause-resume music when connect  
9.volume down



Code	Model	LED Power	Lumen	Size(cm)	Packing info.
io-191010	BT30	30W	2100lm	30*25*38.5	2pcs,53*32.5*41.5cm, 13kgs

**Work Light** rechargeable

LED Qty.: 1pcs Epistar  
 Beam angle: 130°  
 Power: 10W /20W  
 CCT: 3000K/4000K/6000K  
 IP level: IP65  
 Input Voltage of Charger: AC85-265V  
 Input Voltage of Car Charger: DC12-24V  
 Battery Endurance: 5 hours  
 Material: Aluminum  
 Driver: included



■ 5W ■ 10W



Adaptor plug:VDE SAA UK



■ 20W

Code	Model	Battery	Battery Qty	Working time	Charging time	Products Size	Lumens
io-105045	5W	7.4V 2S 2200mAh	2PCS	3 hours	3 hours	165X235X190mm	350lm
io-105046	10W	7.4V 2S2P 4400mAh	4PCS	4 hours	4 hours	165X235X190mm	700lm
io-105047	20W	14.8V 4S2P 4400mAh	4PCS	5 hours	5 hours	240X200X270mm	1400lm