



Let's build a Smart home.



SMART LIVING 2023-2024

Hangzhou Hemos Lighting Co., Ltd.

Quick Preview



- 30 years of experience in electronics manufacturing and export.

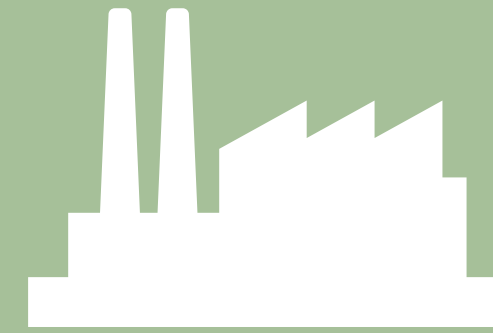

- 1,800 employees
- 48,000,000 pieces of annual production capacity
- 40+ automated production lines



- Decades-long sales relationships with European and North American firms.
- Experienced in serving OEM / ODM demands.

Technological Achievements



- Patented designs
- Such as a universal controller for all Tuya IoT devices.
- First in the field of Tuya smart LED bulbs, filament bulbs, glass GU10 bulbs, and more.



- Third-party labs validates the safety, durability and efficiency of our products.
- More than 100 certificates won: RED-CE, UL, SAA and more.



- Connected to Google Assistant, Amazon Alexa and many other smart home services.
- Local Cloud server with in Europe and North America.

Company Structure

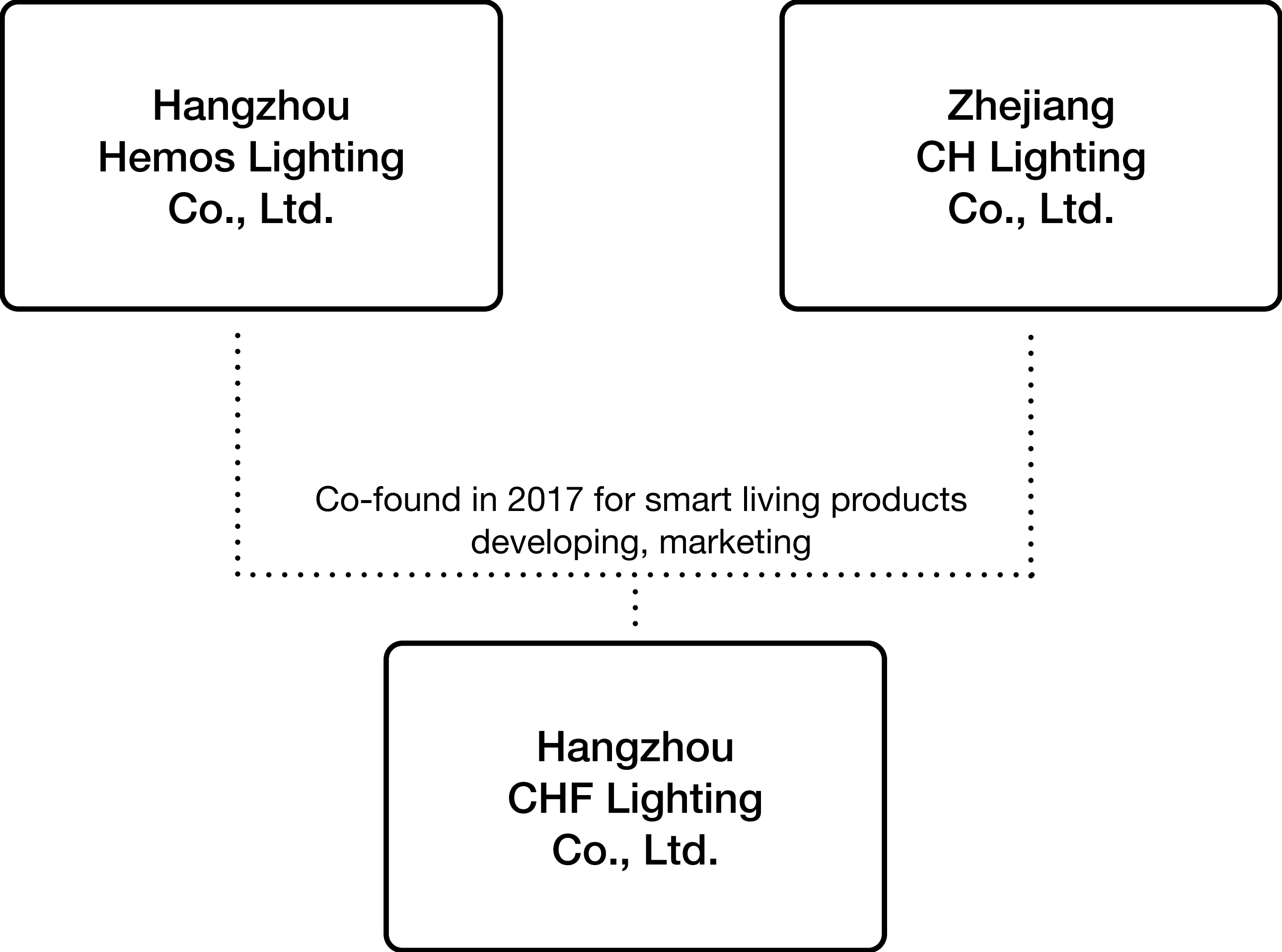

Production Facility Overview

160,000 m² production space in total
Located in Zhejiang





Hand-Assembly Line



In-house Testing Lab



Automated Production





Smart Lighting Products

Powered by  tuya[®]

Smart LED Bulbs



This is our take on the traditional light bulb form factors, melding modern LED technology with simple, elegant designs.

• Dimmable

• Smart Control

• 15000h Life Span

• CCT+Color Control



A60/A70



BR30



C37



GU10



GU10 Glass



Smart Wi-Fi LED Bulb

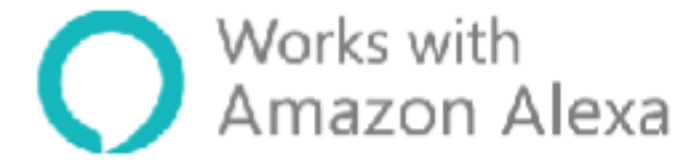

A60



A70



GU10 Glass



GU10



C37

Model	Base	Input Voltage	Power	Luminous Flux	Color Temperature	Life Span	Beam Angle	Dimmable	ErP Rating	Dimension (mm)
io-WiFi60	E27/B22	220-240V	6w	470lm	RGB+W2700K	15000 h	220°	brightness	G	D60*H110
io-WiFi60cct-s	E27/B22	220-240V	9w	806lm	2700K-6500K	15000 h	220°	brightness + color temperature	F	D60*H110
io-WiFi60-2s	E27/B22	220-240V	9w	806lm	RGB+W2700K	15000 h	220°	brightness	F	D60*H110
io-WiFi60-rgb+cct-s	E27/B22	220-240V	9w	806lm	RGB/2700K-6500K	15000 h	220°	brightness+color temperature	F	D70*H133
io-WiFi70-rgbw-s	E27/B22	220-240V	11w	1055lm	RGB+W2700K	15000 h	200°	brightness	F	D70*H133
io-WiFi70rgb+cct-s	E27/B22	220-240V	11w	1055lm	RGB/2700K-6500K	15000 h	200°	brightness+color temperature	F	D70*H133
io-WiFiGU10Gcw	GU10	220-240V	4.5w	385lm	2700-6500K	15000 h	120°	brightness + color temperature	F	D50*H55
io-WiFiGU10G	GU10	220-240V	4.5w	385lm	RGB+W2700K	15000 h	120°	brightness	F	D50*H55
io-WiFiGU10Gw+rgb	GU10	220-240V	4.5w	385lm	RGB/2700K-6500K	15000 h	120°	brightness + color temperature	G	D50*H55
io-WiFiGU10cct	GU10	220-240V	4.5w	326lm	2700-6500K	15000 h	120°	brightness + color temperature	F	D50*H55
io-WiFiGU10	GU10	220-240V	4.5w	326lm	RGB+W2700K	15000 h	120°	brightness	F	D50*H55
io-WiFiGU10wd	GU10	220-240V	4.5w	326lm	RGB/2700K-6500K	15000 h	120°	brightness + color temperature	F	D50*H55
io-WiFi-C37wd	E14	220-240V	4.5w	385lm	2700-6500K	15000 h	160°	brightness + color temperature	F	D37*H108
io-WiFi-C37	E14	220-240V	4.5w	385lm	RGB+W2700K	15000 h	160°	brightness	F	D37*H108
io-WiFi-C37wd-2	E14	220-240V	4.5w	385lm	RGB/2700K-6500K	15000 h	160°	brightness + color temperature	F	D37*H108



Smart Wi-Fi LED Bulb

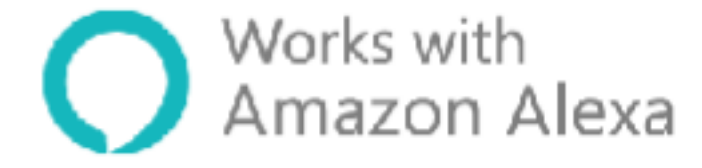

A19



G45



A21



BR30

Model	Base	Input Voltage	Power	Luminous Flux	Color Temperature	Life Span	Beam Angle	Dimmable	Dimension (mm)
io-WiFiA19	E26	110-130V	6w	470lm	RGB+W2700K	15000 h	220°	brightness	D60*H110
io-WiFiA19-2	E26	110-130V	9w	800lm	RGB+W2700K	15000 h	220°	brightness	D60*H110
io-WiFiA19-5	E26	110-130V	9w	800lm	RGB/2700K-6500K	15000 h	220°	brightness + color temperature	D60*H110
io-WiFiA21	E26	110-130V	11w	1050lm	RGB+W2700K	15000 h	220°	brightness	D70*H133
io-WiFiA21-5	E26	110-130V	11w	1050lm	RGB/2700K-6500K	15000 h	220°	brightness+color temperature	D70*H133
io-WiFiBR30	E26	110-130V	8w	700lm	RGB+W2700K	15000 h	110°	brightness	D95*H125
io-WiFiBR30-5	E26	110-130V	8w	700lm	RGB/2700K-6500K	15000 h	110°	brightness+color temperature	D95*H125
io-WiFi60F20	E26	100V, 50/60Hz	9w	810lm	RGB/2700K-6500K	15000 h	220°	brightness+color temperature	D60*H110
io-WiFiG45	E17	100V, 50/60Hz	5w	485lm	RGB/2700K-6500K	15000 h	160°	brightness+color temperature	D45*H87



- **Wireless Bluetooth**
- **Compatible with Android and iOs**
- **Music Player**
- **650lm Warm White**

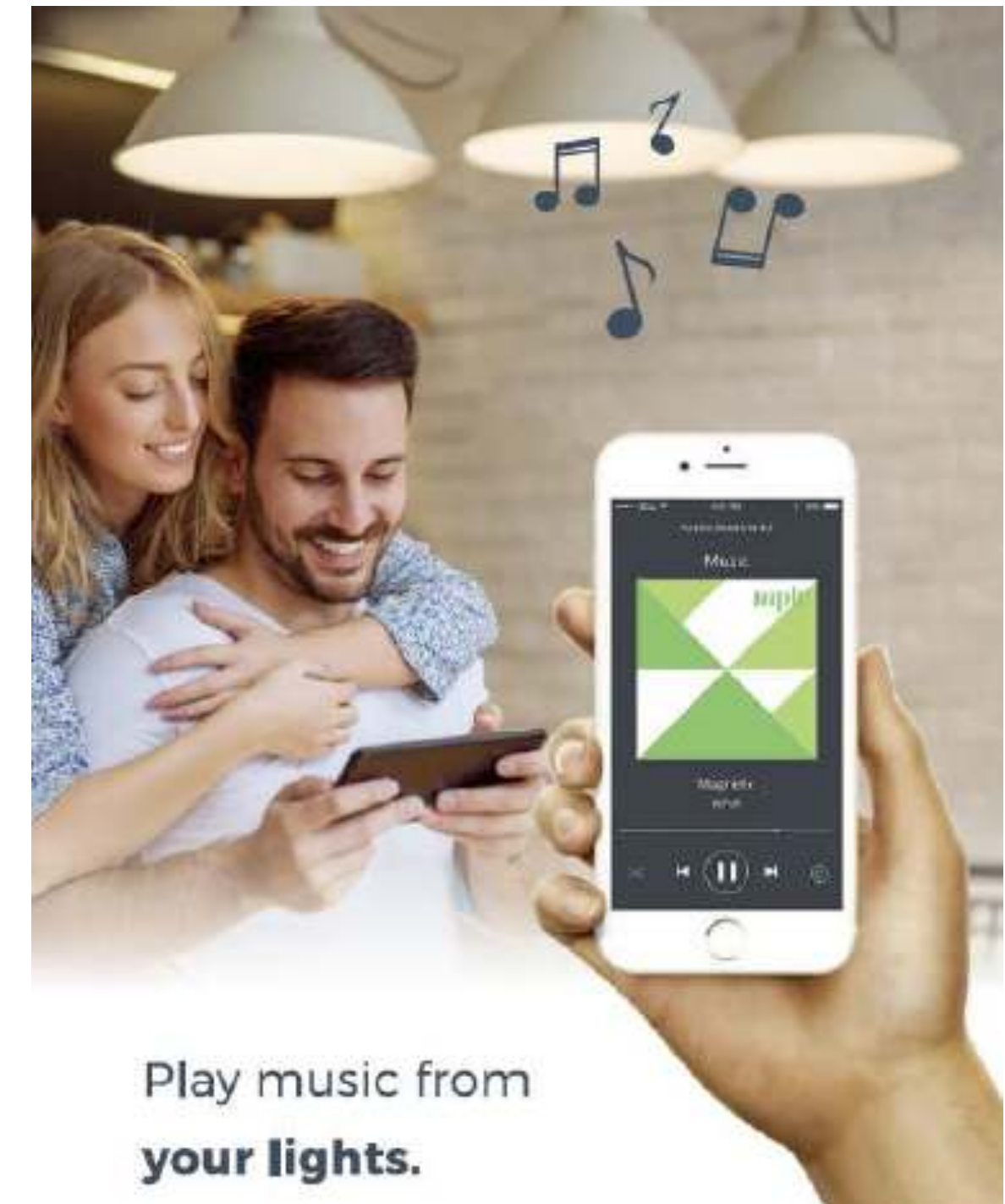

Model	Input Voltage	Power	Luminous Flux	Colour Temp.	Life Span	Dimension (mm)
io-Ble-BR30	120V	11.5W	650lm	3000K	20000 h	D95*H125

Smart Filament Bulbs



Nothing says old-school and cool in lighting better than the filament bulb. Revived with LED technology, our lineup of filament bulb is both capable and classic.

LED Filament Patent Ledisong Certified.

• Dimmable

• Smart Control

• 15000h Life Span

• 3 Unique Finishes



They come in three unique finishes:

Clear

Amber

Milky





A60



ST64



G125

- **LED Filament Patent Ledisong Certified.**
- **Each model comes in 3 finishes:
Clear/ Amber/ Milky**



Model	Base	Input Voltage	Power	Luminous Flux	Color Temperature	Life Span	Beam Angle	ErP Rating	Dimension (mm)
io-WFA60	E27/B22	220-240V	4.9W	470lm	Clear/Milky:2700K Amber: 2200K	15000 h	320°	Clear: F Milky/Amber: G	D60*H105
io-WFST64	E27/B22	220-240V	4.9W	470lm	Clear/Milky:2700K Amber: 2200K	15000 h	320°	Clear: F Milky/Amber: G	D64*H140
io-WFG125	E27/B22	220-240V	4.9W	470lm	Clear/Milky:2700K Amber: 2200K	15000 h	320°	Clear: F Milky/Amber: G	D125*H167
io-WFA60-T	E27/B22	220-240V	4.9W	470lm	2700-6500K	15000 h	320°	Clear: F Milky/Amber: G	D60*H105
io-WFST64-T	E27/B22	220-240V	4.9W	470lm	2700-6500K	15000 h	320°	Clear: F Milky/Amber: G	D64*H140
io-WFG125-T	E27/B22	220-240V	4.9W	470lm	2700-6500K	15000 h	320°	Clear: F Milky/Amber: G	D125*H167
io-WFA60-H	E27/B22	220-240V	7W	806lm	Clear/Milky:2700K Amber: 2200K	15000 h	320°	Clear: F Milky/Amber: G	D60*H105
io-WFST64-H	E27/B22	220-240V	7W	806lm	Clear/Milky:2700K Amber: 2200K	15000 h	320°	Clear: F Milky/Amber: G	D64*H140
io-WFG125-H	E27/B22	220-240V	7W	806lm	Clear/Milky:2700K Amber: 2200K	15000 h	320°	Clear: F Milky/Amber: G	D125*H167
io-WFA60-TH	E27/B22	220-240V	7W	806lm	2700-6500K	15000 h	320°	Clear: F Milky/Amber: G	D60*H105
io-WFST64-TH	E27/B22	220-240V	7W	806lm	2700-6500K	15000 h	320°	Clear: F Milky/Amber: G	D64*H140
io-WFG125-TH	E27/B22	220-240V	7W	806lm	2700-6500K	15000 h	320°	Clear: F Milky/Amber: G	D125*H167

io.e

Smart Premium Filament Bulb

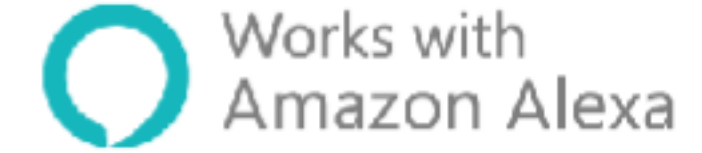
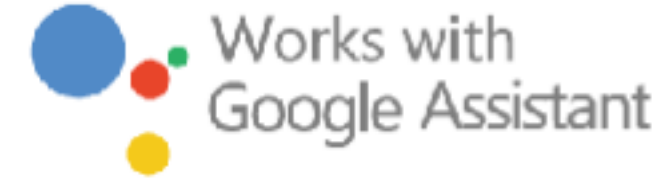

RED CE



A60



ST64



G125

- **LED Filament Patent Ledisong Certified.**
- **Beautifully Twisted Filament**
- **Golden or Clear Glass**



Model	Base	Input Voltage	Power	Luminous Flux	CCT	Lifespan	Beam Angle	ErP Rating	Dimension (mm)
io-WFA60-A-WDFL	E27/B22	220-240V	4.9W	470lm	1800-6500K	15000 h	320°	F	D60*H105
io-WFST64-A-WDFL	E27/B22	220-240V	4.9W	470lm	1800-6500K	15000 h	320°	F	D64*H142
io-WFG125-A-WDFL	E27/B22	220-240V	4.9W	470lm	1800-6500K	15000 h	320°	F	D125*H170
io-WFA60-C-WDFL	E27/B22	220-240V	5.5W	470lm	1800-6500K	15000 h	320°	F	D60*H105
io-WFST64-C-WDFL	E27/B22	220-240V	5.5W	470lm	1800-6500K	15000 h	320°	F	D64*H142
io-WFG125-C-WDFL	E27/B22	220-240V	5.5W	470lm	1800-6500K	15000 h	320°	F	D125*H170



Smart Special Filament Bulb



Let's Try Something Special:

- New Shapes: C35 and G45
- New Finish: Smoke Glass
- New Function: Color Control



Model	Base	Input Voltage	Power	Luminous Flux	Color Temperature	Life Span	Beam Angle	ErP Rating	Dimension (mm)
io-WFG45-C-T	E27/B22	220-240V	4.9W	470lm	1800-3000K	15000 h	320°	F	D45*H78
io-WFG45-M-T	E27/B22	220-240V	4.9W	470lm	2200-4000K	15000 h	320°	F	D45*H78
io-WFC35-C-T	E14	220-240V	4.9W	470lm	1800-3000K	15000 h	320°	F	D35*H116
io-WFC35-M-T	E14	220-240V	4.9W	470lm	2200-4000K	15000 h	320°	F	D35*H116
io-WFC35-A	E14	220-240V	4.9W	470lm	2200K	15000 h	320°	F	D35*H116
io-WFG125-M-RGBCW	E27/B22	220-240V	5.5W	380lm	RGB/2700K-6500K	15000 h	320°	G	D125*H172
io-WFG125-M-RGBW	E27/B22	220-240V	4.9W	240lm	RGB+W1800K	15000 h	320°	G	D125*H172
io-WFG125-S	E27/B22	220-240V	7W	400lm	1800K	15000 h	320°	G	D125*H172
io-WFST64-S	E27/B22	220-240V	7W	400lm	1800K	15000 h	320°	G	D64*H142

  **Smart LED Indoor Light**

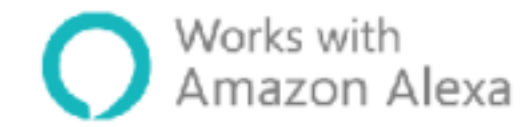

A modern take on the traditional form. Now our spotlights, down lights, ceiling lights, panel lights and table lamps have all been smarten up.

• **Dimmable**

• **Smart Control**

• **Long Life Span**

• **Voice Control**



Table Lamp



Panel Light



Spot Light



Ceiling Light



Smart Wi-Fi Mood Light

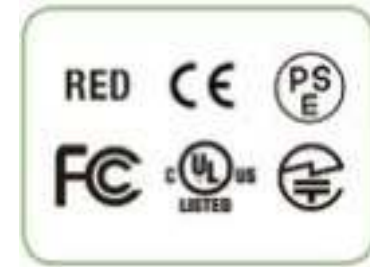

- **RGB+CCT Control**
- **Voice Control**
- **Biorhythm**
- **Wellness Function**

—Aptly named, this carefully designed lamp could create ambiance in a room with delicate combinations of hue, color temperature and brightness. What’s more, the Wellness Function allows this lamp to adjust color and brightness according to the wake up time you set, which can improve sleep quality and help you to wake up refreshingly.



Model	Input Voltage	Power	Luminous Flux	Color Temperature	Dimmable	Dimension (mm)
io-WiFi-ML-RGBCCT	100-240V	4.9W	360lm	RGB+CCT/ 2700-6500K	Brightness + Color Temperature	Body D200 Base D120

There are multiple scientific studies on the effect that light has on sleep quality and general well-being.

Based on these studies, Tuya Smart developed the Wellness Function. This exciting new feature enables lighting devices to gradually and scientifically adjust color, brightness and temperature of the light according to the time of day. It can simulate sunlight, or you can also set the light that you'd like to wake up and fall asleep to.

• Biorhythm



• Light to Wake





Smart Panel Light

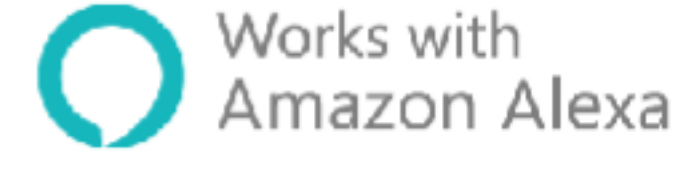
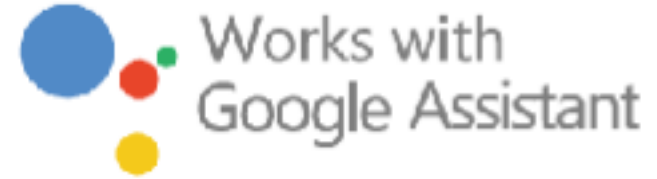

- **Straight Down Type**
- **Smart Control**
- **RA>80**
- **3-way Installation**
- **Wi-Fi or Bluetooth Technology**

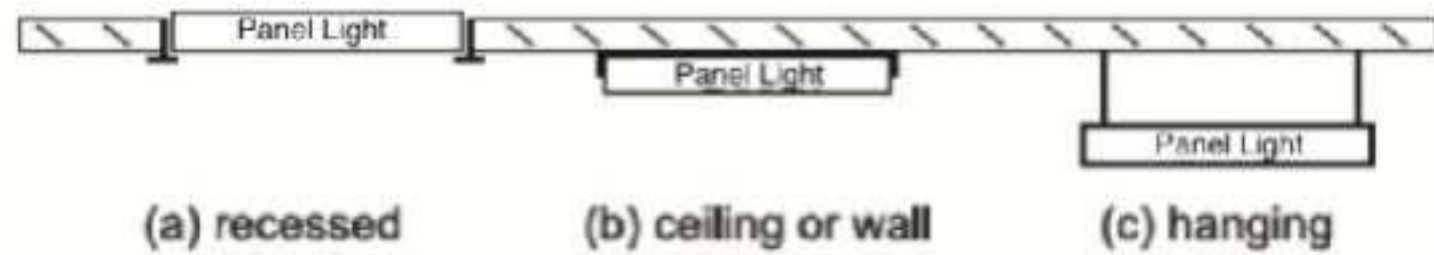

Model	Input Voltage	Power	Luminous Flux	Color Temperature	Dimmable	Dimension (mm)
LK-WiFi-D	220-240V	40W	4000lm	4000K	Brightness	595*595
LK-WiFi-DW	220-240V	40W	4000lm	3000K-4000K-6500K	Brightness + Color Temperature	595*595



Smart T5 Batten Light

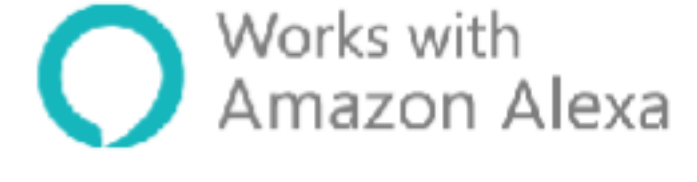

- **Smart Control**
- **Integrated PC Housing**
- **Linkable**
- **30000 Hours Life Span**



Model	Input Voltage	Power	Luminous Flux	Color Temperature	Beam Angle	Dimension (mm)
io-WiFi2355-4	220-240V	4W	400lm	3000-6500K	150°	313*22*30
io-WiFi2355-8	220-240V	8W	800lm	3000-6500K	150°	573*22*30
io-WiFi2355-14	220-240V	14W	1400lm	3000-6500K	150°	1173*22*30
io-WiFi2355-18	220-240V	18W	1800lm	3000-6500K	150°	1473*22*30



Smart Spotlight



- Smart Control
- Aluminum Housing
- Focus Lighting
- 30000 Hours Life Span



Model	Input Voltage	Power	Luminous Flux	Color Temperature	Beam Angle	Dimension (mm)
io-WiFi4335-3	220-240V	3W	210lm	3000K/4000K/6500K	35°	Φ95*46(cutout Φ68mm)
io-WiFi4335-6	220-240V	6W	420lm	3000K/4000K/6500K	35°	Φ95*46(cutout Φ68mm)
io-WiFi4335-8	220-240V	8W	560lm	3000K/4000K/6500K	35°	Φ106*53(cutout Φ78mm)
io-WiFi4335F-3	220-240V	3W	210lm	3000K/4000K/6500K	35°	95*95*46(cutout Φ68mm)
io-WiFi4335F-6	220-240V	6W	420lm	3000K/4000K/6500K	35°	95*95*46(cutout Φ68mm)
io-WiFi4335F-8	220-240V	8W	560lm	3000K/4000K/6500K	35°	106*106*53(cutout Φ78mm)



Smart Retrofit Down Light

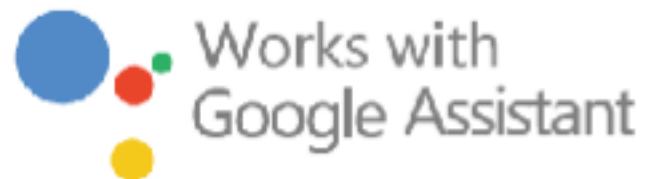

- Smart Control
- CCT+Color Control
- Easy to Install



Model	Input Voltage	Power	Base	Luminous Flux	Color Temperature	Dimension
io-WiFiDL4-2	120V	8.7W	E26	700lm	2700-6500K	4"
io-WiFiDL4-5	120V	8.7W	E26	700lm	RGB/2700-6500K	4"
io-WiFiDL6-2	120V	10W	E26	800lm	2700-6500K	5/6"
io-WiFiDL6-5	120V	10W	E26	800lm	RGB/2700-6500K	5/6"



Smart Ceiling Light

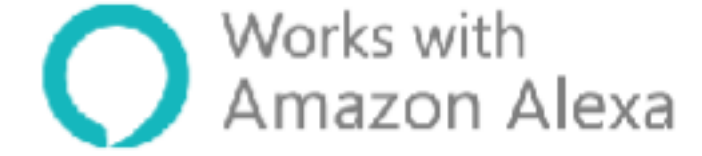

- **Classic Design**
- **Smart Control**
- **Dimmable**
- **Color Control / CCT Control**



Model	Input Voltage	Power	Luminous Flux	Colour Temp.	Dimmable	IP Rating	Dimension (mm)
io-WiFiCLDW	220-240V	18W	1400lm	3000-6500K	Brightness+CCT	IP 20	D320
io-WiFiCLRGBW	220-240V	18W	1400lm	RGB+W3000K	Brightness	IP 20	D320



Smart Slim Ceiling Light

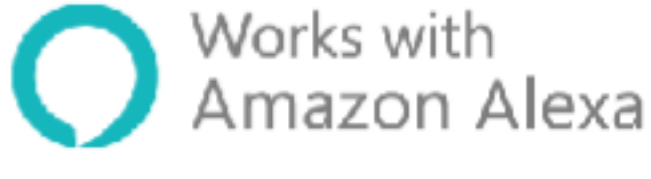
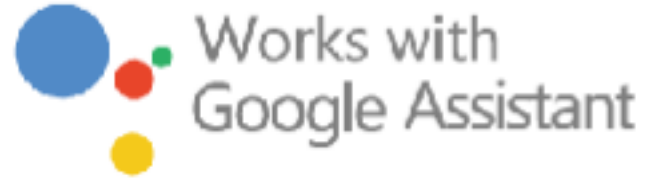

- Slim Design
- Smart Control
- IR Control
- Dimmable
- CCT Control



Model	Input Voltage	Power	Luminous Flux	Colour Temp.	IP Rating	Frame Color	Dimension (mm)
io-WiFiCL293	220-240V	18W	2400lm without Cover 1700lm with Cover	2700-6500K	IP 20	White/ Black/ Silver	D293*28.5
io-WiFiCL420	220-240V	22W	3000lm without Cover 2200lm with Cover	2700-6500K	IP 20	White/ Black/ Silver	D420*28.5



Smart Ceiling Light with Back Light



- RGB Back Light
- Smart Control
- IR Control
- Dimmable
- CCT Control



Model	Input Voltage	Power	Luminous Flux	Colour Temp.	IP Rating	Frame Color	Dimension (mm)
io-WiFiCL360-5	220-240V	28w	2000lm without Cover 1600lm with Cover	2700-5000K RGB 16 color back light	IP 20	Black/ White	D360*80



Smart IP44 Ceiling Light



- IP44 Waterproof
- Indoor or Outdoor
- Smart Control
- IR Control
- Dimmable
- CCT Control



Model	Input Voltage	Power	Luminous Flux	Colour Temp.	IP Rating	Frame Color	Dimension (mm)
io-WiFiCL280-44	220-240V	15w	2000lm without Cover 1500lm with Cover	2700-6500K	IP 44	Black/ White/ Silver	D280*28

Smart LED Decoration Light



A flexible addition to any lighting setup that melds light into creative shapes and forms onto almost any surface.

- Smart Control

- Remote Control

- Decorative

- Voice Control



Strip Light



String Light

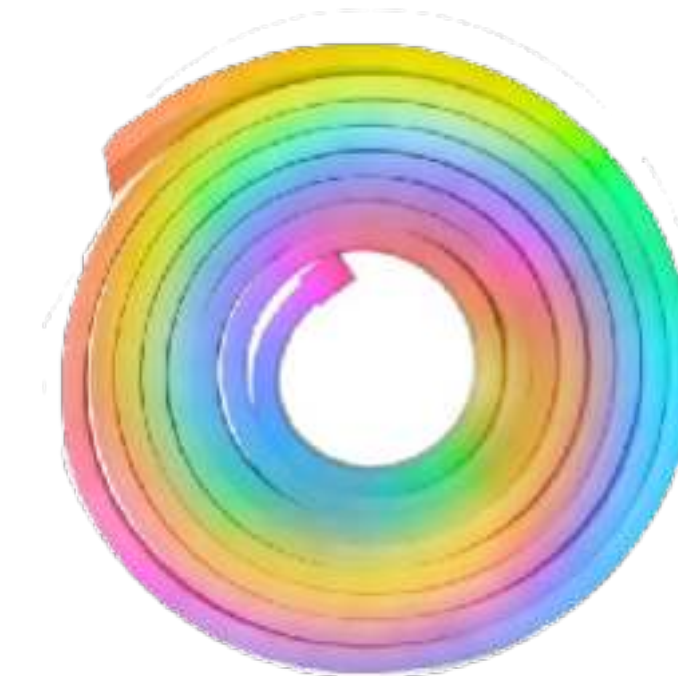

Neon Light



Smart Strip Light

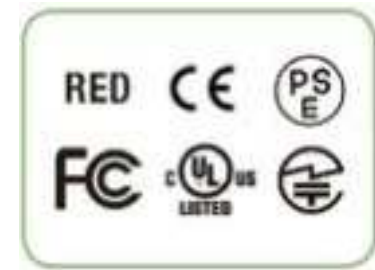

- **Smart Control**
- **Dimmable**
- **Music Mode Option**



Model	Power	Luminous Flux	Color	IP Rating (For LED Strips)	Dimension (mm)
io-WiFi-LS5	24W	800lm for White	RGBW	IP44	12.5*5000
io-WiFi-LSWD5	24W	800lm	CCT	IP44	10*5000
io-WiFi-LS5-2	24W	800lm for White	RGBCCT	IP44	12.5*5000
io-WiFi-LS3	24W	800lm for White	RGBW	IP44	12.5*3000
io-WiFi-LSWD3	24W	800lm	CCT	IP44	10*3000
io-WiFi-LS3-2	24W	800lm for White	RGBCCT	IP44	12.5*3000
io-WiFi-LS5-IP	24W	800lm for White	RGBW	IP65	12.5*5000



Smart String Light

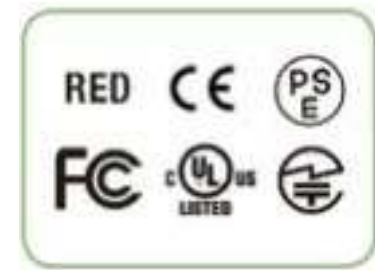

- **Smart Control & Remote Control**
- **Built-in Microphone**
- **Music Mode**
- **IP44 Version Can be Used Outdoor**

It's hard to imagine holidays without colorful lightings and music. With a built-in high-sensitivity microphone, our smart string lights can change color with its surrounding sound. Wrap them on the Christmas tree, or simply put them on furnitures, it's easy to meld the string lights with anything you want to decorate. Open your favorite playlist, the light can sync with music to create a fantastic atmosphere for the party.

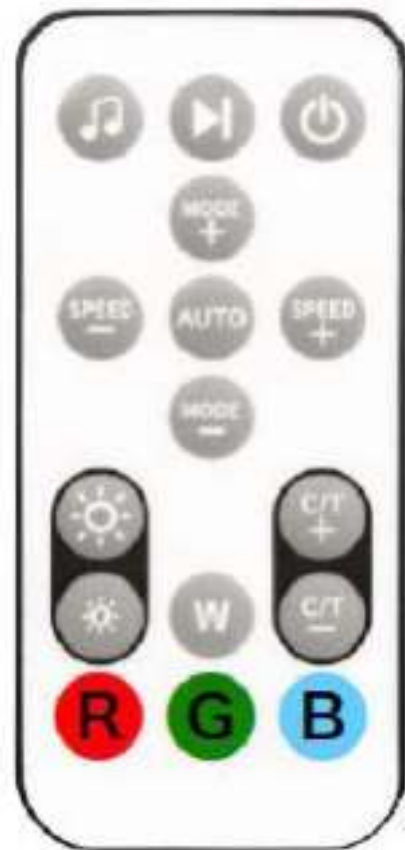

Model	String Description	String Length	LEDs	Power Input	IP Rating	Remote Controller	Color
io-MSL1	Copper Wire and Round-shaped Light Source	5m	50 LEDs	USB DC 5V/1A	IP20	Infrared	RGB
io-MSL2	Copper Wire with Round-shaped Light Source	10m	100 LEDs	USB DC 5V/2A	IP20	Infrared	RGB
io-MSL11	Leather Wire with Round-shaped Light Source	5m	33 LEDs	IP44 Adapter 5V/1.2A	IP44	Infrared	RGB
io-MSL12	Leather Wire with Round-shaped Light Source	10m	66 LEDs	IP44 Adapter 5V/1.2A	IP44	Infrared	RGB
io-WSL11	Leather Wire with Bullet-shaped Light Source	5m	33 LEDs	IP44 Adapter 5V/1.2A	IP44	Infrared	RGB
io-WSL12	Leather Wire with Bullet-shaped Light Source	10m	60 LEDs	IP44 Adapter 5V/1.2A	IP44	Infrared	RGB



Smart Neon Rope Light

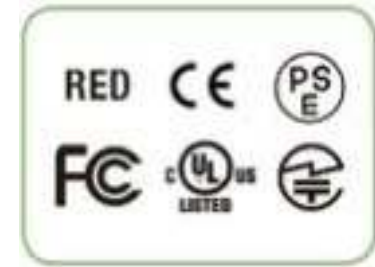

- Smart Control & Remote Control
- IP67 Waterproof
- Programmable Light Patterns
- Silicone Material
- Music Mode

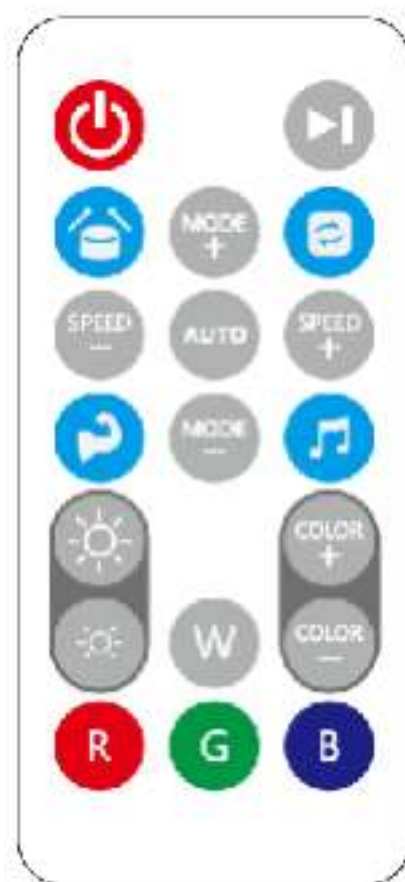

Model	Input Voltage	Power	Color	LEDs	IP Rating (For Rope Light)	Working Temperature	Dimension (mm)
io-NHWSC6	DC24V 1.5A	42W	RGBIC	84LEDs/m	IP 67	-20°C-40°C	5000*8*17



Smart Outdoor Light

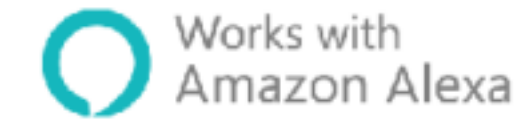

• Floodlight



Lanzini

• Spike Light



Rossi

• Wall Light



Colombo

• Wall Light and Bollard Light Series



Greco



Romano



Moretti

We have both Bluetooth and Wi-Fi version of smart outdoor lights. Wi-Fi outdoor lights are suitable for small gardens. For big gardens, we strongly recommend the Bluetooth version, since the Gateway allows connection of **more devices at extended range**.



Bluetooth Version

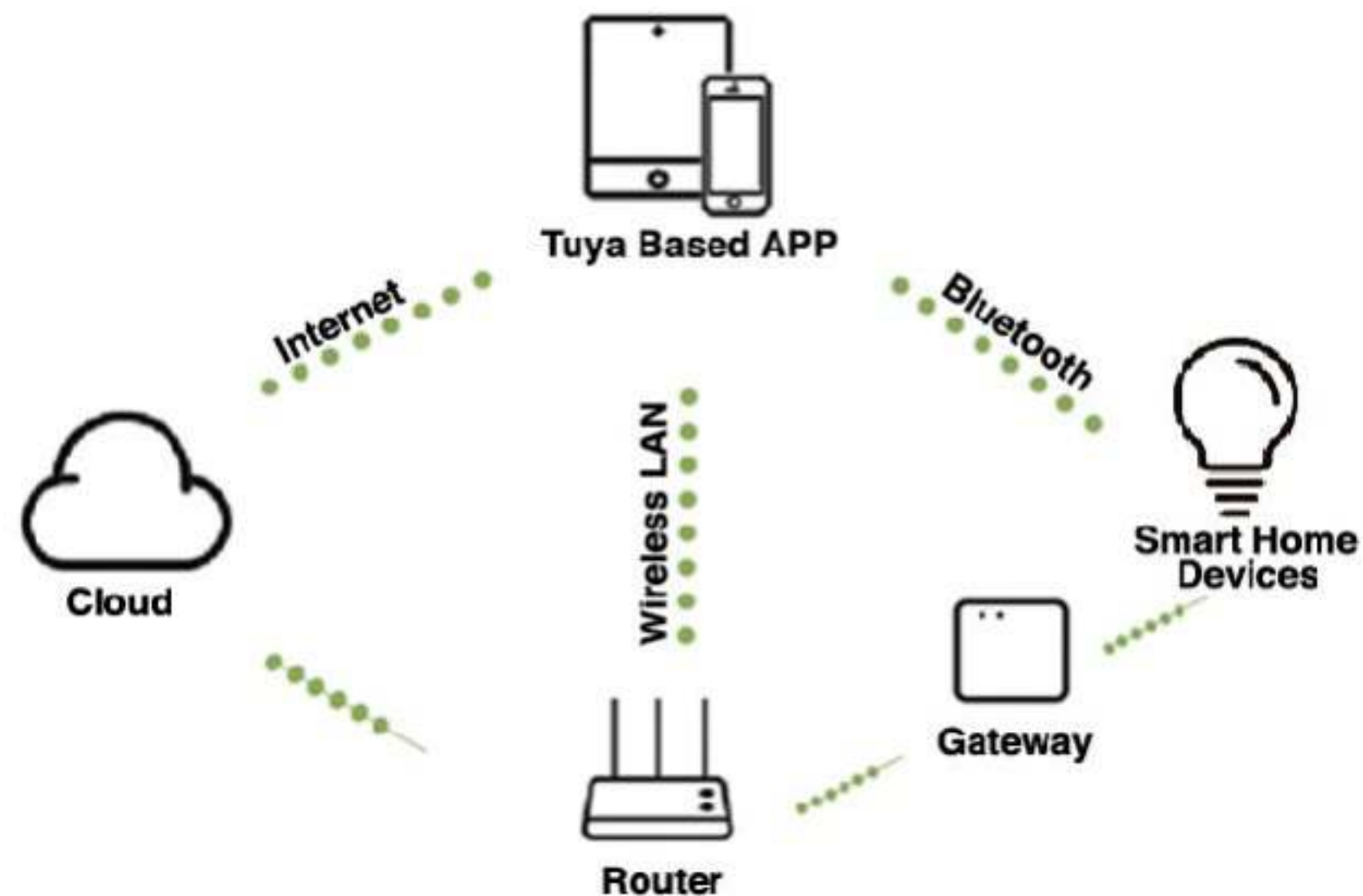

- **Connects More Devices**
- **Extended Range**



Wi-Fi Version

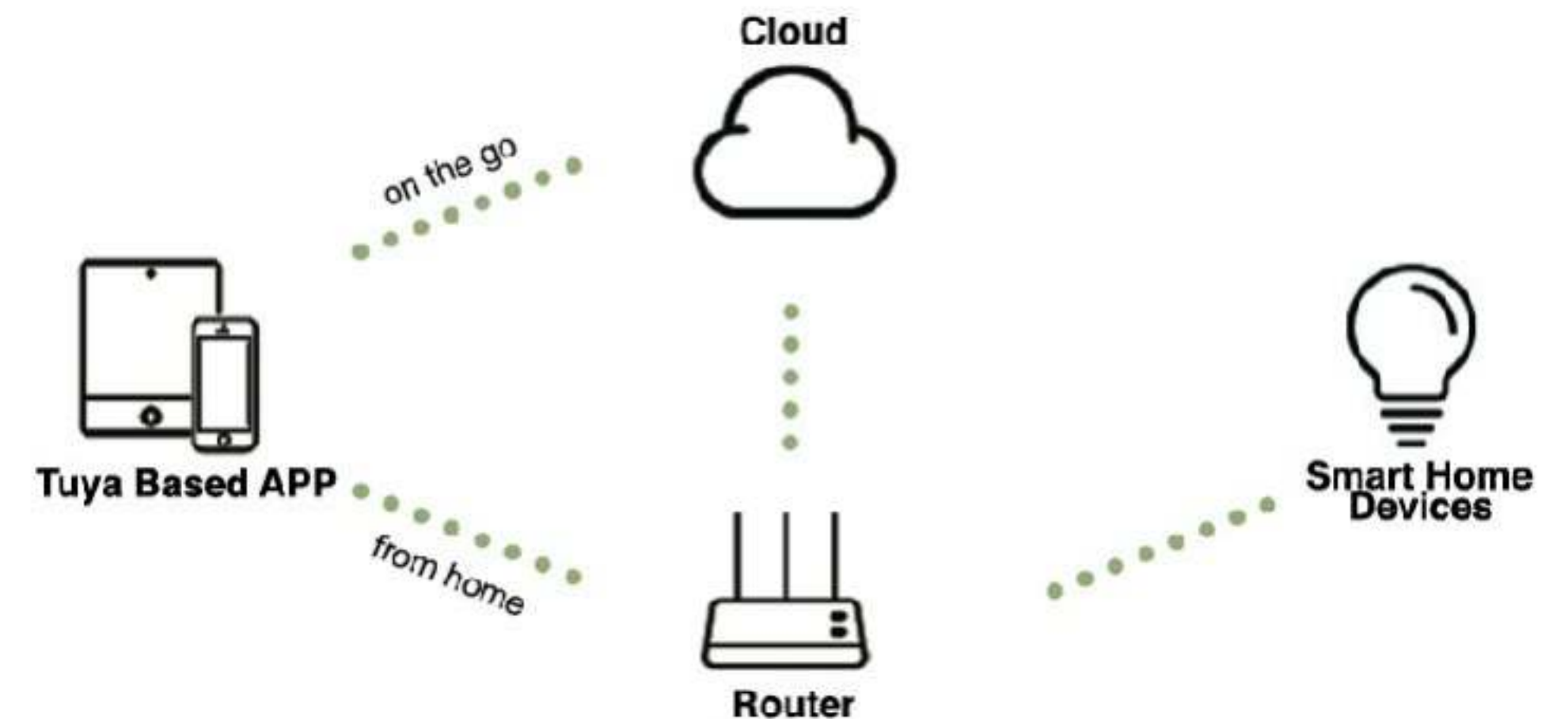

- **No Gateway Required**



Smart Floodlight

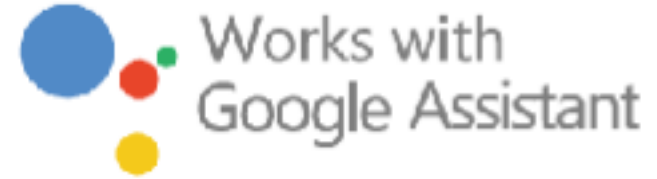

Lanzini

- IP65 Certified
- Dimmable
- Color Control
- Smart Control



Model	Input Voltage	Power	Luminous Flux	Colour Temp.	Dimmable	Dimension (mm)
io-BleM-FL10	220-240V	10W	800 lm	RGB+W2700K	Brightness	114*108*66.2
io-BleM-FL20	220-240V	20W	1600 lm	RGB+W2700K	Brightness	136*136*80



Smart Spike Light

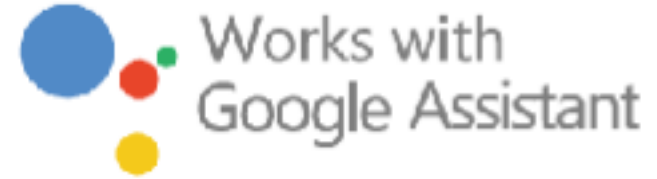

- IP65 Certified
- Dimmable
- Color Control
- Smart Control
- With Plug and 0.5m Cable



Rossi

Model	Input Voltage	Power	LED	Colour Temp.	Dimmable	Dimension (mm)
io-BleM-LRS3	12V DC	3W	3pcs 5050RGB	RGB	Brightness	φ60*80*270



Smart Spike Light Kit



+



- 3 Spike Lights + IP44 Gateway Plug

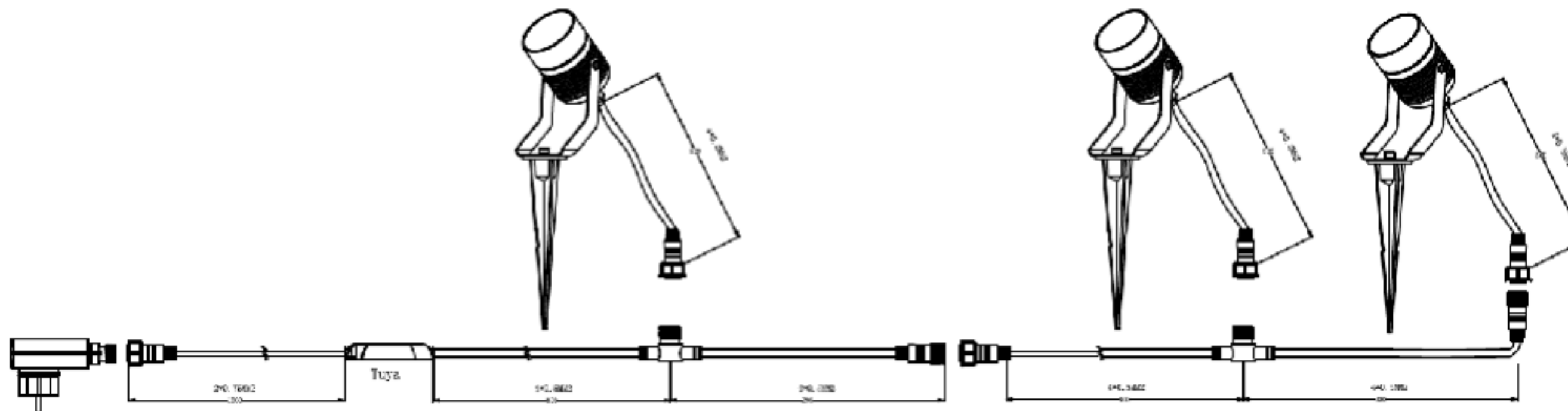

Model	Input Voltage	Power	LED	Colour Temp.	Dimmable	Dimension (mm)
io-BleM-LRS3-3	12V DC	3W*3	3pcs 5050RGB	RGB	Brightness	φ60*80*270



Smart Wall Light

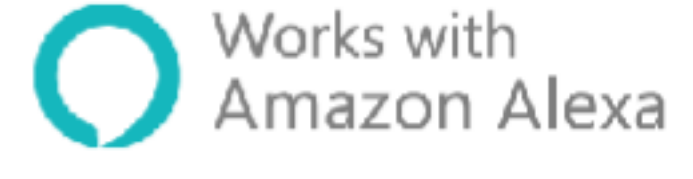

- IP65 Certified
- Dimmable
- Color / CCT Control
- Up & Down Light
- Adjustable Beam Angle

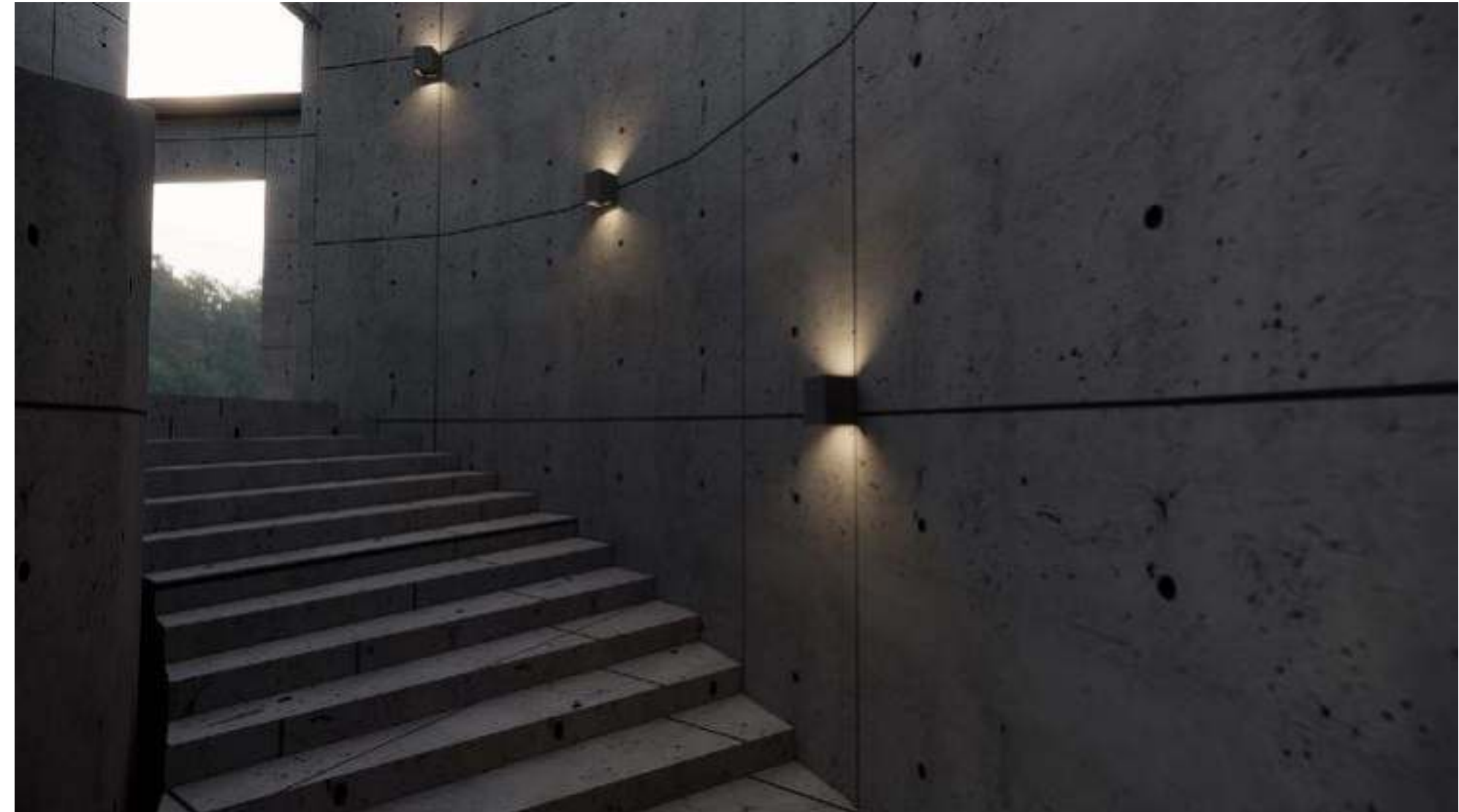

Colombo

Model	Input Voltage	Power	LED	Colour Temp.	Dimmable	Dimension (mm)	Adjustable
io-BleM-WL4D	220-240V	12w(2700k) 4w(RGB)	12pcs 2835+ 12pcs 5050 RGB	RGB+W2700K	Brightness	100*100*125	Hood 0°~100°
io-BleM-WL2D	220-240V	12w	36pcs 2835	2700-6500K	Brightness + CCT	100*100*125	Hood 0°~100°
io-BleM-WL4L	220-240V	18w(2700k) 4w(RGB)	18pcs 2835+ 12pcs 5050 RGB	RGB+W2700K	Brightness	110*130*160	Hood 0°~100°
io-BleM-WL2L	220-240V	18W	48pcs 2835	2700-6500K	Brightness + CCT	110*130*160	Hood 0°~100°



Smart Wall Light



Greco

- IP65 Certified
- Dimmable
- Color Control
- Smart Control



Model	Input Voltage	Power	LED	Colour Temp.	Dimmable	Dimension (mm)
io-BleM-WL4	220-240V	10w(2700k) 4w(RGB)	14pcs 2835+ 6pcs 3030RGB	RGB+W2700K	Brightness	D120*H176



Smart Bollard Light

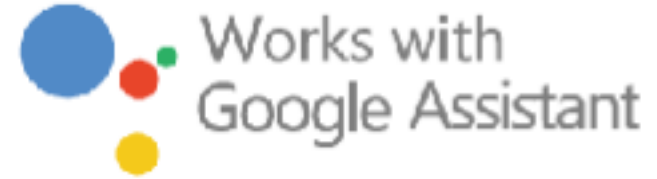

- IP65 Certified
- Dimmable
- Color Control
- Smart Control



Greco

Model	Input Voltage	Power	LED	Colour Temp.	Dimmable	Dimension (mm)
io-BleM-BL4	220-240V	10w(2700k) 4w(RGB)	14pcs 2835+ 6pcs 3030RGB	RGB+W2700K	Brightness	D120*H300



Smart Wall Light

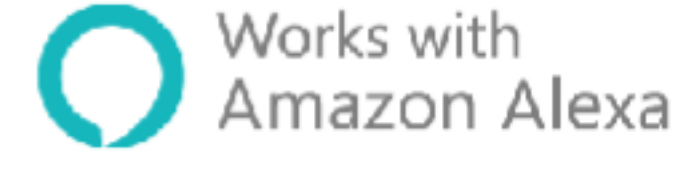
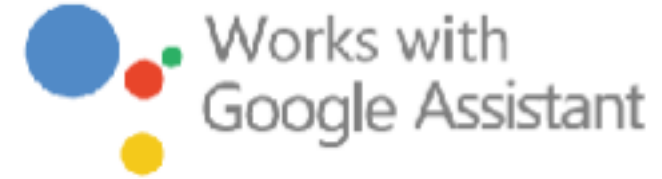

Romano

- IP65 Certified
- Dimmable
- Color/ CCT Control
- Smart Control



Model	Input Voltage	Power	LED	Colour Temp.	Dimmable	Dimension (mm)
io-BleM-WL4R	220-240V	10w(2700k) 4w(RGB)	14pcs 2835+ 6pcs 5050 RGB	RGB+W2700K	Brightness	D200*H90
io-BleM-WL2R	220-240V	10w	28pcs 2835	2700-6500K	Brightness + CCT	D200*H90



Smart Bollard Light



- IP65 Certified
- Dimmable
- Color/ CCT Control
- Smart Control



Romano

Model	Input Voltage	Power	LED	Colour Temp.	Dimmable	Dimension (mm)
io-BleM-BL4R	220-240V	10w(2700k) 4w(RGB)	14pcs 2835+ 6pcs 5050 RGB	RGB+W2700K	Brightness	φ200*90*600mm
io-BleM-BL2R	220-240V	10w	28pcs 2835	2700-6500K	Brightness + CCT	φ200*90*600mm



Smart Wall Light

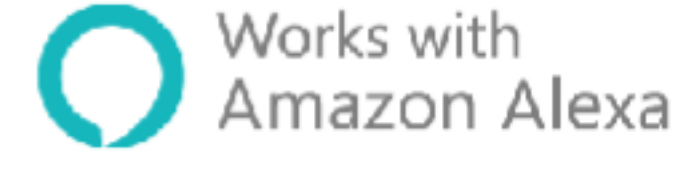
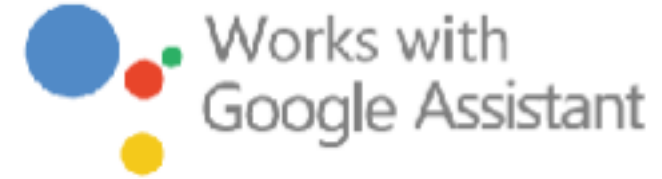

Moretti

- IP65 Certified
- Dimmable
- Color/ CCT Control
- Adjustable Beam Angle



Model	Input Voltage	Power	LED	Colour Temp.	Dimmable	Dimension (mm)	Adjustable
io-BleM-WL4T	220-240V	8w(2700k) 4w(RGB)	9pcs 2835+ 6pcs 5050 RGB	RGB+W2700K	Brightness	190*50*160	Head -45°~+45°
io-BleM-WL2T	220-240V	8w	28pcs 2835	2700-6500K	Brightness + CCT	190*50*160	Head -45°~+45°



Smart Bollard Light

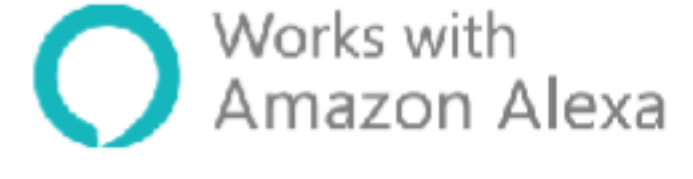
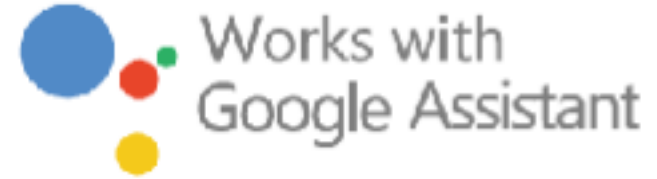

- IP65 Certified
- Dimmable
- Color/ CCT Control
- Adjustable Beam Angle



Moretti

Model	Input Voltage	Power	LED	Colour Temp.	Dimmable	Dimension (mm)	Adjustable
io-BleM-BL4T	220-240V	8w(2700k) 4w(RGB)	9pcs 2835+ 6pcs 5050 RGB	RGB+W2700K	Brightness	160*50*600	Head -45°~+45°
io-BleM-BL2T	220-240V	8w	28pcs 2835	2700-6500K	Brightness + CCT	160*50*600	Head -45°~+45°



Smart PIR Floodlight

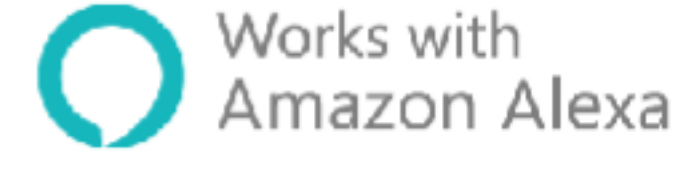
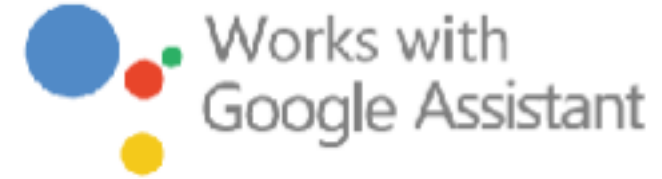

With motion sensor, our Smart PIR Floodlight can be activated automatically when it detects motion. It's ideal for outdoor places that need automatic lighting.

- **Motion Sensor:**
120° angle, 8±2m range.
- **IP44 Waterproof**
- **Smart Control**
- **CCT 2700-6500K**



Model	Input Voltage	Power	Luminous Flux	Color Temperature	IP Rating	Motion Sensor	Dimension (mm)
io-BleM-FL14P	220V-240V	14W	1500lm	2700-6500K	IP44	120° angle, 8±2m range	136*58.5*175
io-BleM-FL24P	220V-240V	24W	2500lm	2700-6500K	IP44	120° angle, 8±2m range	160*58.5*195

Smart LED Batten Light



Classic damp-proof light with smart LED tubes, to be a simple solution for Smart LED Batten Light. Meanwhile considering the better group control effect, we use Bluetooth Mesh technology with iO.e gateway. And add an option with PIR sensor and door/window sensor which can set scene action by Tuya APP.

- **Classic Model**

- **Smart Control**

- **IP65 Certified**

- **Smart Scenes**





Smart BLE T8 Tube

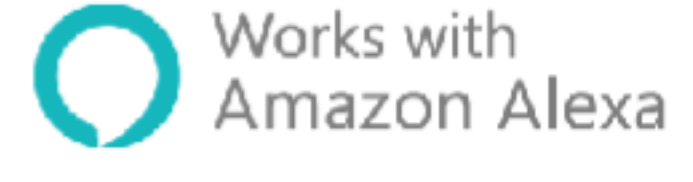

- **CCT changeable**
- **Group control**
- **Dimmable**

Model	Input Voltage	Power	Luminous Flux	CCT	Dimmable	Lifespan	Beam Angle	Dimension (mm)
io-Blem-T8EM60	220-240V	9W	1100lm	2700-6500K	Brightness+CCT	30000 h	360°	600*26
io-Blem-T8EM120	220-240V	18W	2300lm	2700-6500K	Brightness+CCT	30000 h	360°	1200*26
io-Blem-T8EM150	220-240V	24W	3100lm	2700-6500K	Brightness+CCT	30000 h	360°	1500*26



Smart LED Batten

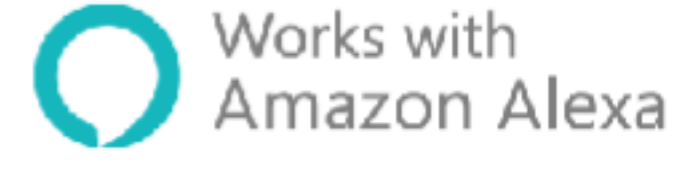

SLB Classic
LED Tube Version

- **Smart LED Tube**
- **Dimmable**
- **CCT Changeable**
- **Group Control**
- **IP65 Waterproof**

Model	Input Voltage	Power	Luminous Flux	CCT	Dimmable	IP Rating	Dimension (mm)
io-F7110T	220-240V	1*9W	1100lm	2700-6500K	Brightness+CCT	IP65	670*68*84
io-F7210T	220-240V	2*9W	2*1100lm	2700-6500K	Brightness+CCT	IP65	670*104*84
io-F7120T	220-240V	1*18W	2300lm	2700-6500K	Brightness+CCT	IP65	1270*68*84
io-F7220T	220-240V	2*18W	2*2300lm	2700-6500K	Brightness+CCT	IP65	1270*104*84
io-F7124T	220-240V	1*24W	3100lm	2700-6500K	Brightness+CCT	IP65	1570*68*84
io-F7224T	220-240V	2*24W	2*3100lm	2700-6500K	Brightness+CCT	IP65	1570*104*84



Smart LED Batten

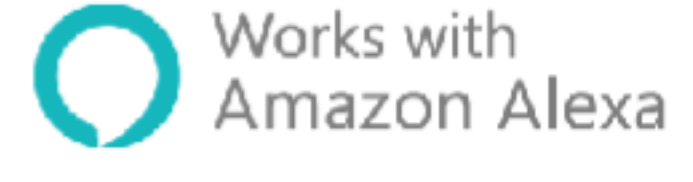

SLB 2020
LED PCBA Version



- **LED PCBA**
- **Dimmable**
- **Group Control**
- **IP65 Waterproof**

Model	Input Voltage	Power	Luminous Flux	CCT	Dimmable	IP Rating	Dimension (mm)
io-2383-150c	220-240V	30W	2700lm	4000K	Brightness	IP65	1500x63x45
io-2383-60d	220-240V	22W	2100lm	4000K	Brightness	IP65	600x72x65
io-2383-120d	220-240V	43W	4200lm	4000K	Brightness	IP65	1200x72x65
io-2383-150d	220-240V	60W	5600lm	4000K	Brightness	IP65	1500x72x65



Smart Security Devices



- **Synergy**
- **Push Alert**
- **High Reliability**
- **Bluetooth Technology**



Device	Power	Operating Conditions	Dimension (mm)	Description
Window/ Door Sensor	Battery Life Up to 12 Months	0-49°C	63.5*25.5*10	Detects opening and closing between 2 components and synergies with other smart devices.
Motion Sensor (PIR)	Battery Life Up to 12 Months	0-49°C	51*51*25.5	Detects movement and synergies with other smart devices. Sensitivity adjustable in smart APP.



Smart Gateway

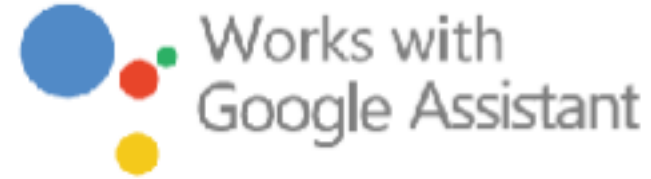

- Works the Same as a WiFi Plug, Plus a Built-in SIG Bluetooth Hub
- Link More Than 30 Devices
- IP44 Version Can be Used Outdoor

Model	Input Voltage	Max Power	Max Current	IP Rating	Power Meter Function	Dimension (mm)
io-WiFi-PlugHub	230V	3680W	16A	IP 20	Yes	L54*W78*H101
io-WiFi-PlugHub-IP44	230V	3680W	16A	IP 44	Yes	L58*W90*H115



- Low Power Usage
- Compact Size
- Link More Than 30 Devices

Model	Power Supply	Communication Technology	Dimension (mm)
io-Hub-BLE-sig	5V/ 1A Micro-USB	WiFi + SIG Bluetooth Mesh	60*60*25

• Smart Led Batten Light System

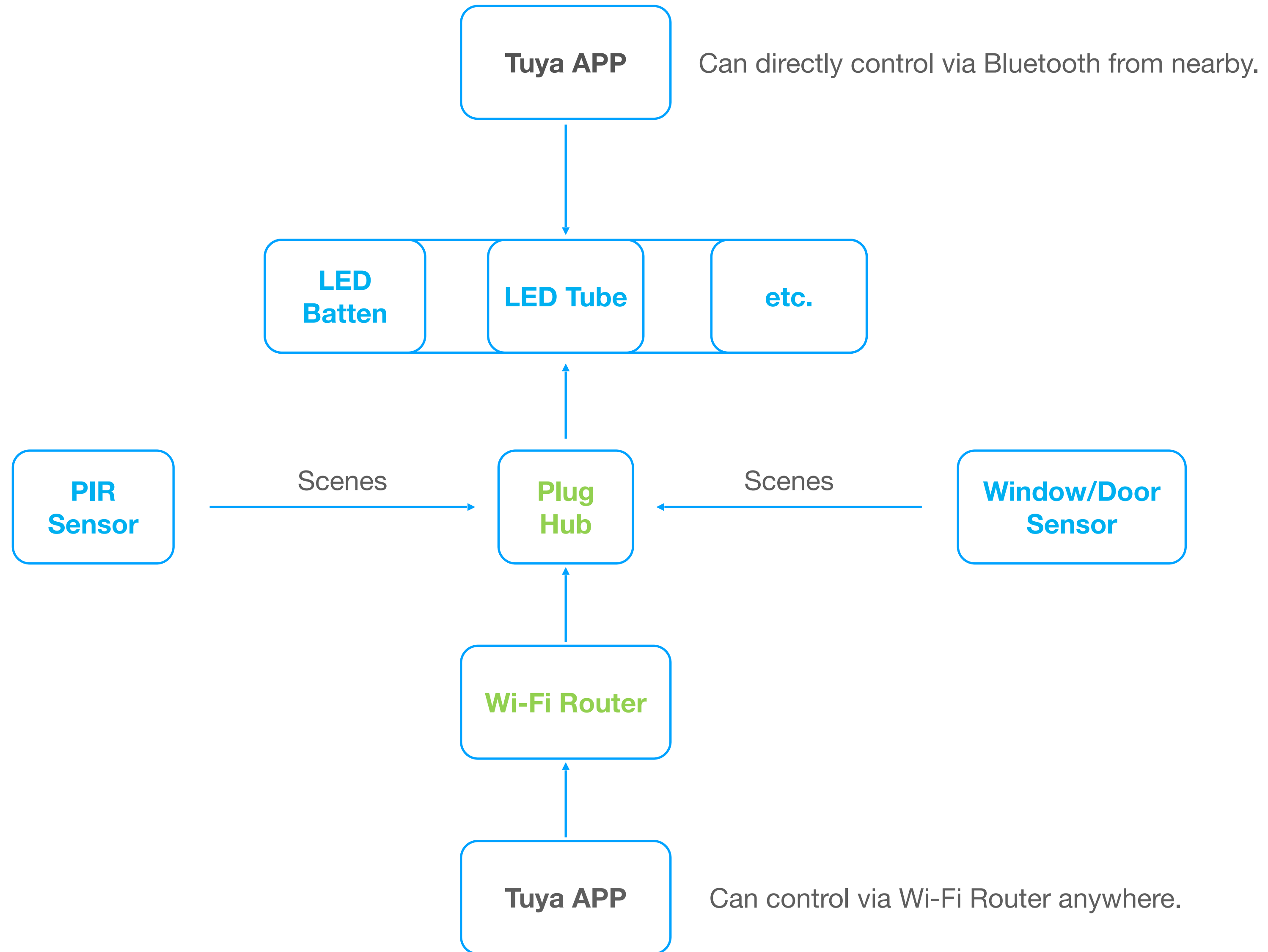

- **Smart Led Batten Light System**

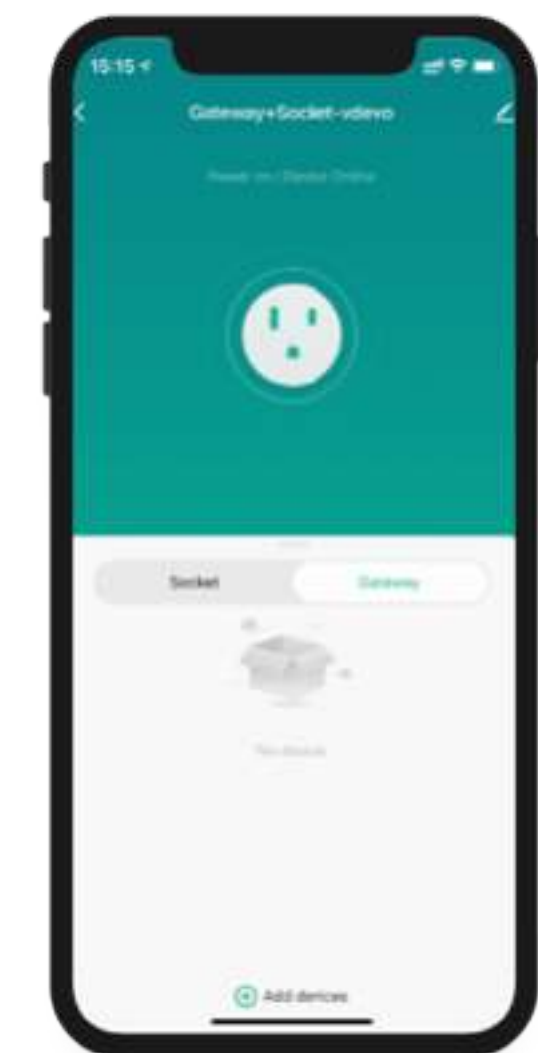
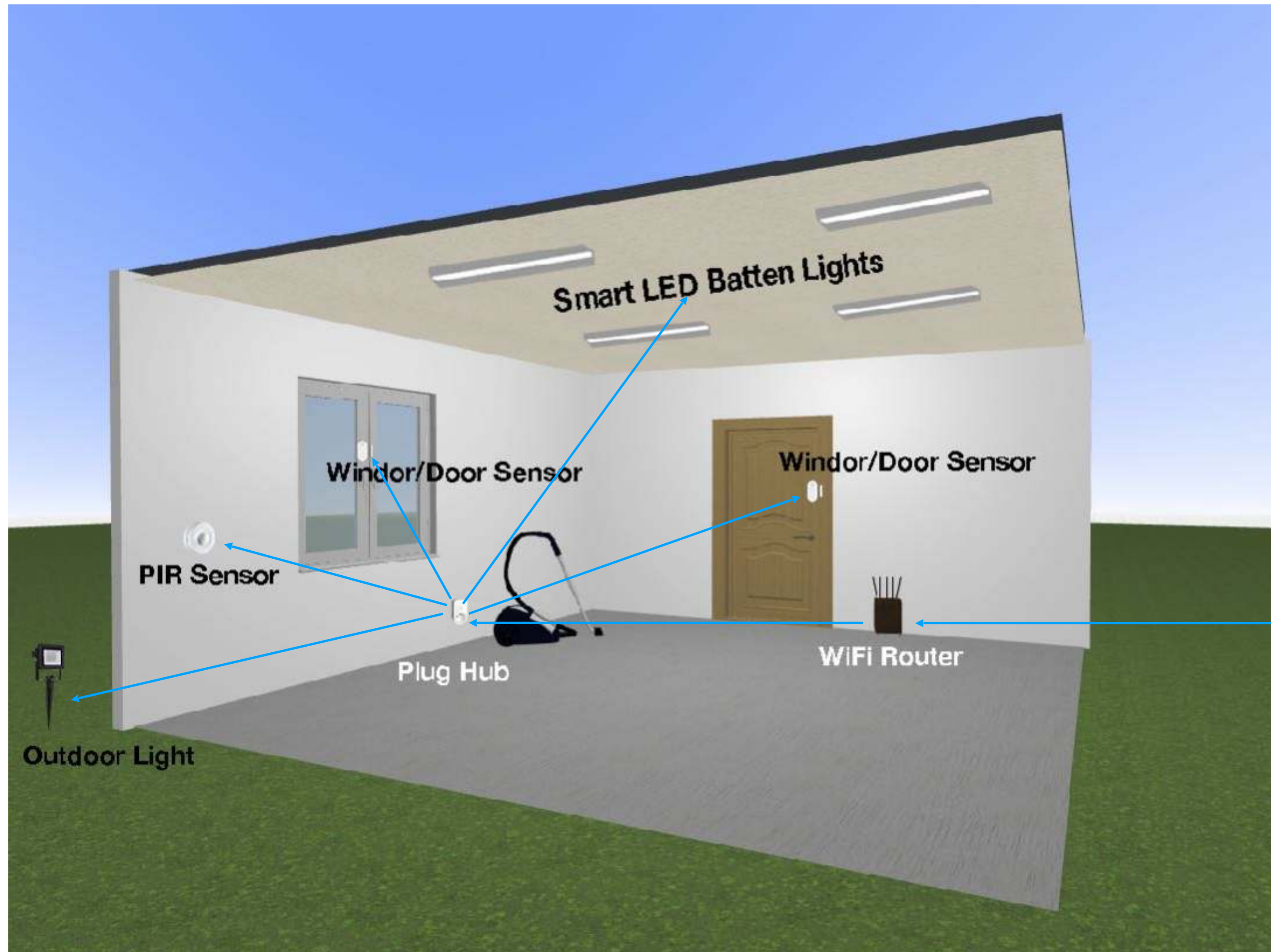

Tuya APP



Smart Electric Products

Powered by  tuya[®]

Our smart plugs, smart power strips and smart wall switches can easily make your home smarter without buying new home appliances. The smart plugs and smart power strips are capable of power metering.

• **Smart Control**



• **Voice Control**



• **Group Control**



• **Physic Control**





Smart Wi-Fi Plug

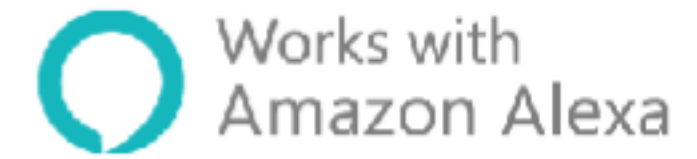

- Smart Control
- Power Meter Function
- Physical Control
- Group Control



Model	Input Voltage	Max Power	Max Current	IP Rating	Power Meter Function	Dimension (mm)
io-WiFi-Plug	230V	3680W	16A	IP 20	Yes	L54*W78*H101
io-WiFi-Plug-IP44	230V	3680W	16A	IP 44	Yes	L58*W90*H115



Smart Wi-Fi Plug

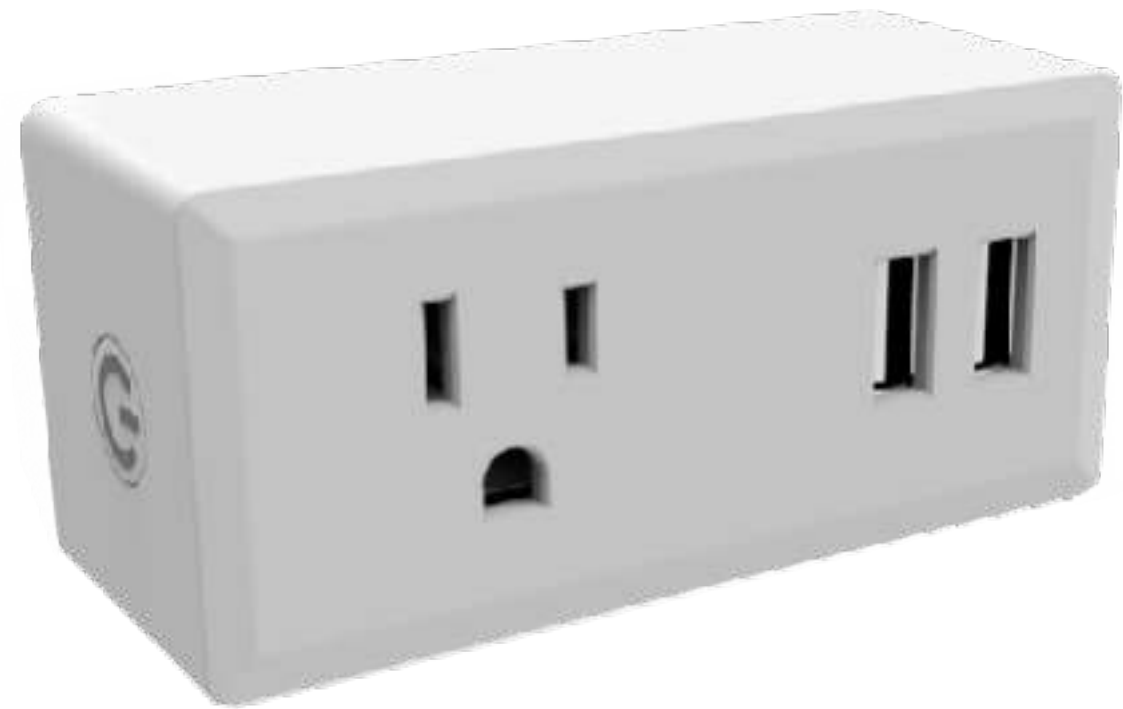
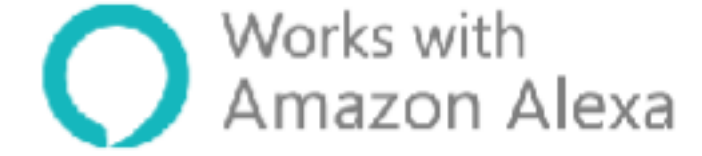

Plug1962

- **Smart Control**
- **Physical Control**
- **Group Control**



Plug2006



Plug1964

Model	Input Voltage	Max Power	Max Current	IP Rating	USB Output
io-WiFi-Plug1962	125V	12500W	10A	IP 20	5V 2.1A
io-WiFi-Plug1964	125V	1875W	15A	IP 20	/
io-WiFi-Plug2006	125V	1875W	15A	IP 20	/

Smart Wi-Fi Plug Types

Our combined lineup supports plugs with Type A, B, C, D, E, F, G, H, I, J, L, M standards as shown in the diagram below.

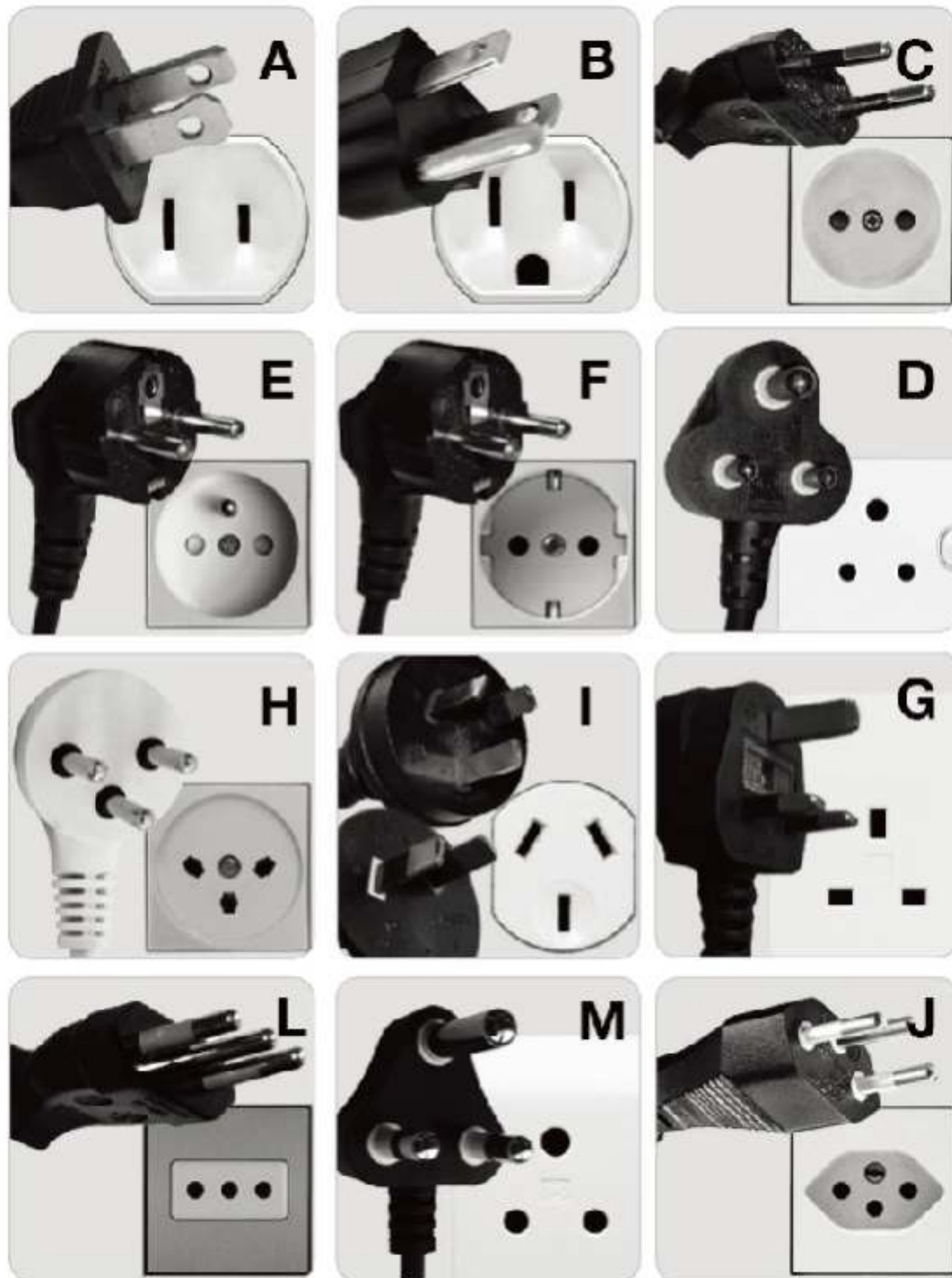

Model	Socket Type Supported	Best For (Example)
io-WiFi-PlugEU	C E F	European Standard
io-WiFi-PlugFR	C E F	France
io-WiFi-PlugAU	I	Australia
io-WiFi-PlugUK	G	United Kingdom
io-WiFi-PlugJP	A	Japan
io-WiFi-PlugSA	M	South Africa
io-WiFi-PlugIT	C L	Italy
io-WiFi-PlugNA	A B	North America
io-WiFi-PlugIL	C H	Istael
io-WiFi-PlugCH	C J	Switzerland
io-WiFi-PlugIN	D	India



Smart Gateway Plug



- Works the Same as the WiFi Plug with Built-in SIG Bluetooth Hub
- Can Link More Than 30 Tuya Bluetooth Devices



Model	Input Voltage	Max Power	Max Current	IP Rating	Power Meter Function	Dimension (mm)
io-WiFi-PlugHub	230V	3680W	16A	IP 20	Yes	L54*W78*H101
io-WiFi-PlugHub-IP44	230V	3680W	16A	IP 44	Yes	L58*W90*H115



Smart Dimming Plug

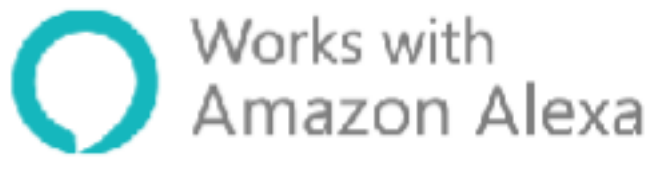

- Turn Your Traditional Lights into Smart
- Smart Control
- Dim Control

(To use dimming function, the lights connected should be capable of Triac dimming mode.)



Model	Input Voltage	Loading Capacity @60V LED Light	Loading Capacity @120V Incandescent Light	Loading Capacity @220V Incandescent Light	Power Meter Function	Dimension (mm)
io-WiFiOS-EU	100-240V	80W	150W	200W	No	L54*W78*H101
io-WiFiOS-FR	100-240V	80W	150W	200W	No	L54*W78*H101



Smart Power Strip



- **Independent Control of Each Sockets**
- **Smart Control**
- **Overload Protection**

Model	Input Voltage	Max Power	Current	Single USB Output
io-WiFi-pstrEU	230V	3680W	16A max	2.4A max
io-WiFi-pstrFR	230V	3680W	16A max	2.4A max
io-WiFi-pstrAU	230V	2400W	10A max	2.4A max



Smart Wall Switch

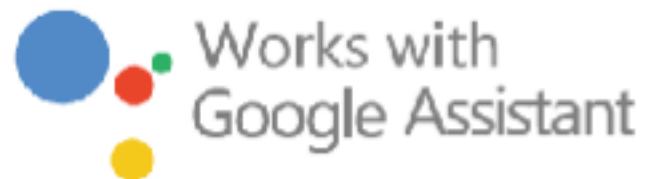

- **Touch Panel**
- **Smart Control**
- **Power Efficient**



Replaces Traditional Wall Switches



Controls Electric Curtains/Blinds



Model	Control	Voltage	Current	Standby Consumption	Dimming
io-WiFi-ws1	1 Gang Switch	100-240 V	10A	0.5W max	No
io-WiFi-ws2	2 Gang Switch	100-240 V	10A	0.5W max	No
io-WiFi-ws3	3 Gang Switch	100-240 V	10A	0.5W max	No
io-WiFi-wswd	Dimmer Switch	100-240 V	10A	0.5W max	Yes
io-WiFi-cs	Curtain Switch	100-240 V	10A	0.5W max	N/A



Smart Wall Switch

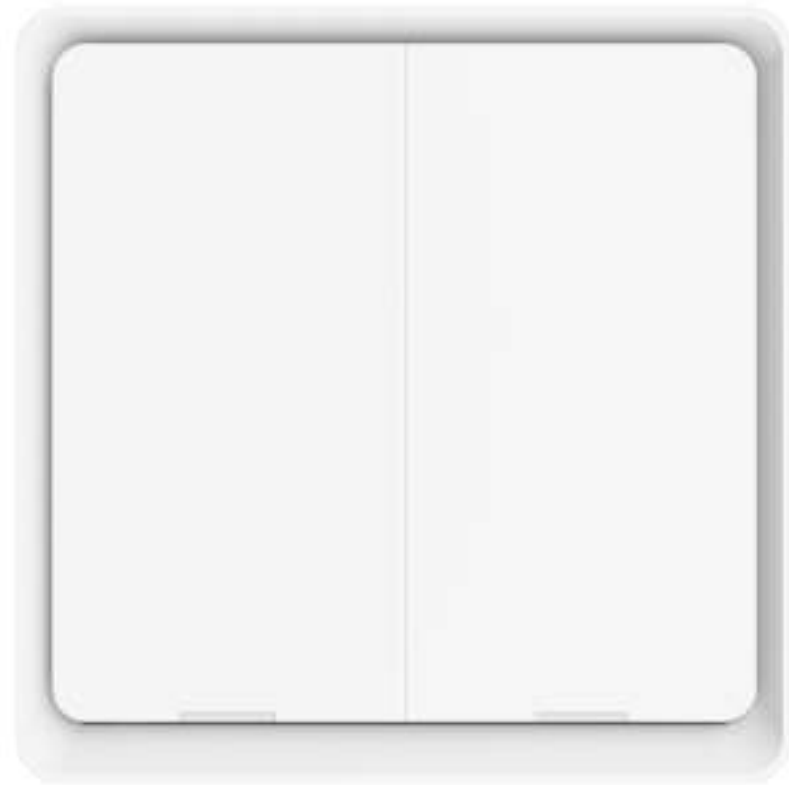
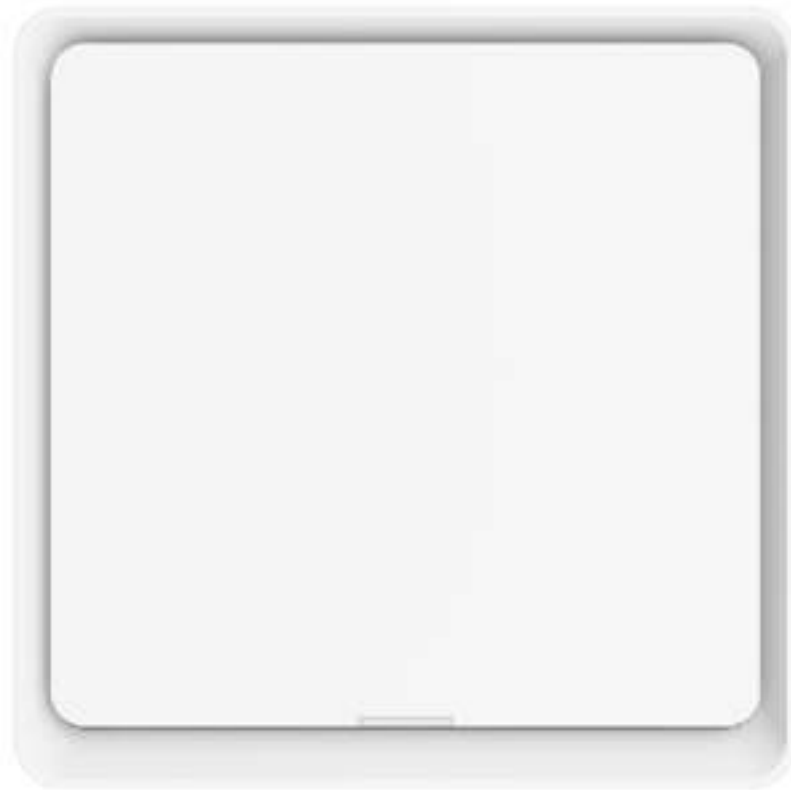
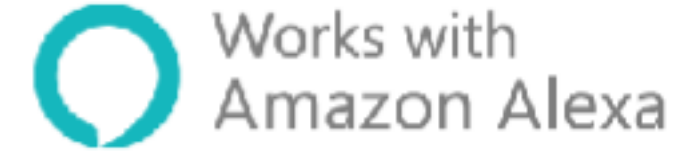

- Customization ID Available
- Shell: PC UL94, Fire Rating V0
- Wi-Fi or Zigbee Technology

Model	Control	Description	Dimension (mm)	Certificate
io-EU-ws1	1 Gang Switch	No neutral version: Input: AC 200-240V, 50Hz/60Hz; 1way load: Resistive load 5-1500W, LED5-500W Neutral required version: Input 110-240V, 50Hz/60Hz; 1way load: MAX2200W	86*86*37.5	CE RED+LVD UKCA RoHS & Reach
io-EU-ws2	2 Gang Switch	No neutral version: Input: AC 200-240V, 50Hz/60Hz; 1way load: Resistive load 5-1500W, LED5-500W Neutral required version: Input 110-240V, 50Hz/60Hz; 1way load: MAX2200W	86*86*37.5	CE RED+LVD UKCA RoHS & Reach
io-EU-ws3	3 Gang Switch	Neutral required version: Input 110-240V, 50Hz/60Hz; 1way load: MAX2200W	86*86*37.5	CE RED+LVD UKCA RoHS & Reach
io-EU-wswd	Dimmer Switch	Input Voltage: AC 100-240V, 50Hz/60Hz Dimming Control: Trial edge Current: 2.5A Max load: Inductive Load(LED/CFL/Fan: 220W max, Resistive Load(Incandescent): 300W max Button lifecycle: 500k	86*86*43	CE RED+LVD UKCA RoHS & Reach

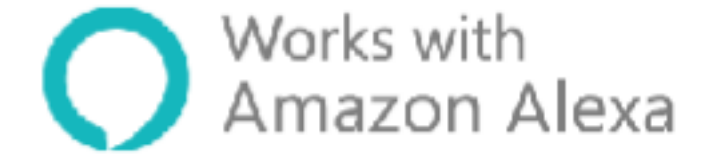
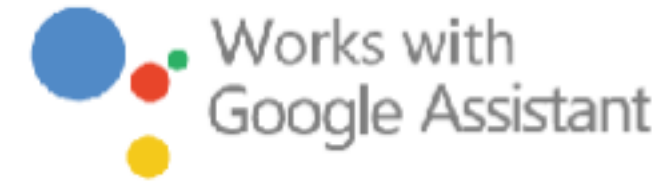

Our Product's Advantages

Traditional switch
and smart switch
independent control
non-interfering

You can use the switch
control the power state

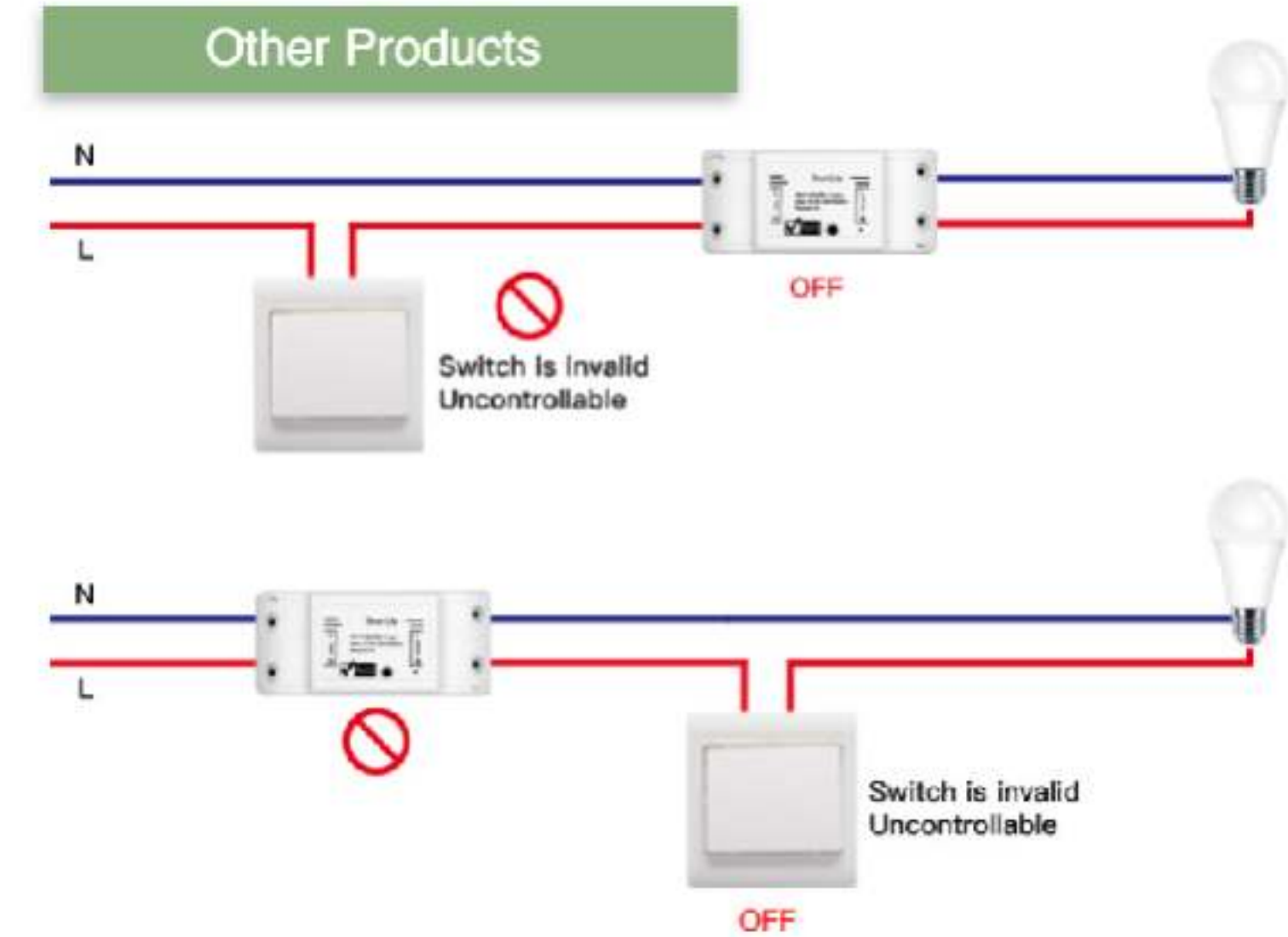
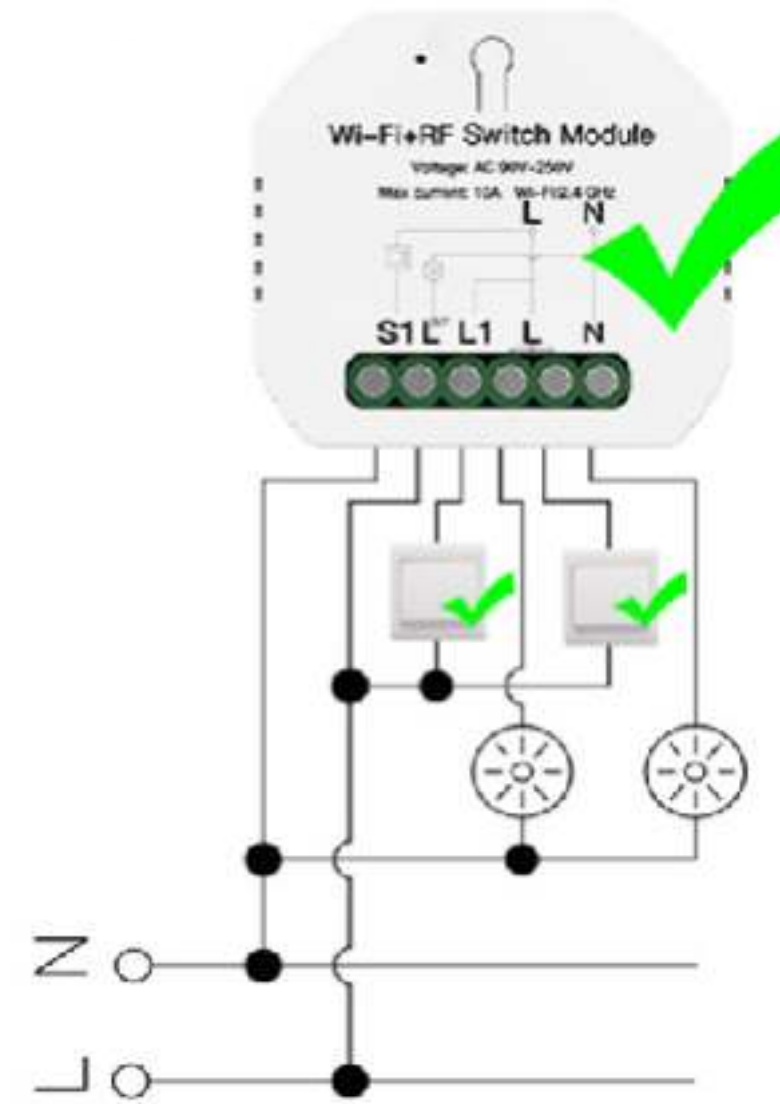

Model	Control	Input Voltage	Max Current	Max Load (Resistive)	Max Load (LED)	RF Mode
io-WiFi-ms1	1 Gang with WiFi BK Module	90-250 V	10A	2200VA W	250VA W	Yes
io-WiFi-ms2	2 Gang with WiFi BK Module	90-250 V	10A	2200VA W	250VA W	Yes
io-WiFi-ms3	3 Gang with WiFi BK Module	90-250 V	10A	2200VA W	250VA W	No
io-WiFi-msd1	1 Gang Dim WiFi ESP Module	90-250 V	10A	150VA W	150VA W	No
io-WiFi-msd2	2 Gang Dim WiFi ESP Module	90-250 V	10A	2*100VA W	2*100VA W	No



Smart Light Controller



- Turn Your Traditional Lights into Smart
- Smart Control
- Dim Control

(To use dimming function, the lights connected should be capable of Triac dimming mode.)



Model	Control	Input Voltage	Max Load
io-WiFiOS	Triac Dimming Mode Lights	100-240V	Loading Capacity @60V LED Light: 60W Loading Capacity @120V Incandescent Light: 150W Loading Capacity @220V Incandescent Light: 200W
io-WiFi-LS-ctr	RGBW LED Strip Light Controller	12V/24V DC	100W
io-WiFi-LSRGB-ctr	RGB LED Strip Light Controller	12V/24V DC	100W
io-WiFi-LSW-ctr	White LED Strip Light Controller	12V/24V DC	100W
io-WiFi-LSWD-ctr	CCT LED Strip Light Controller	12V/24V DC	100W



Smart Button



● Patented

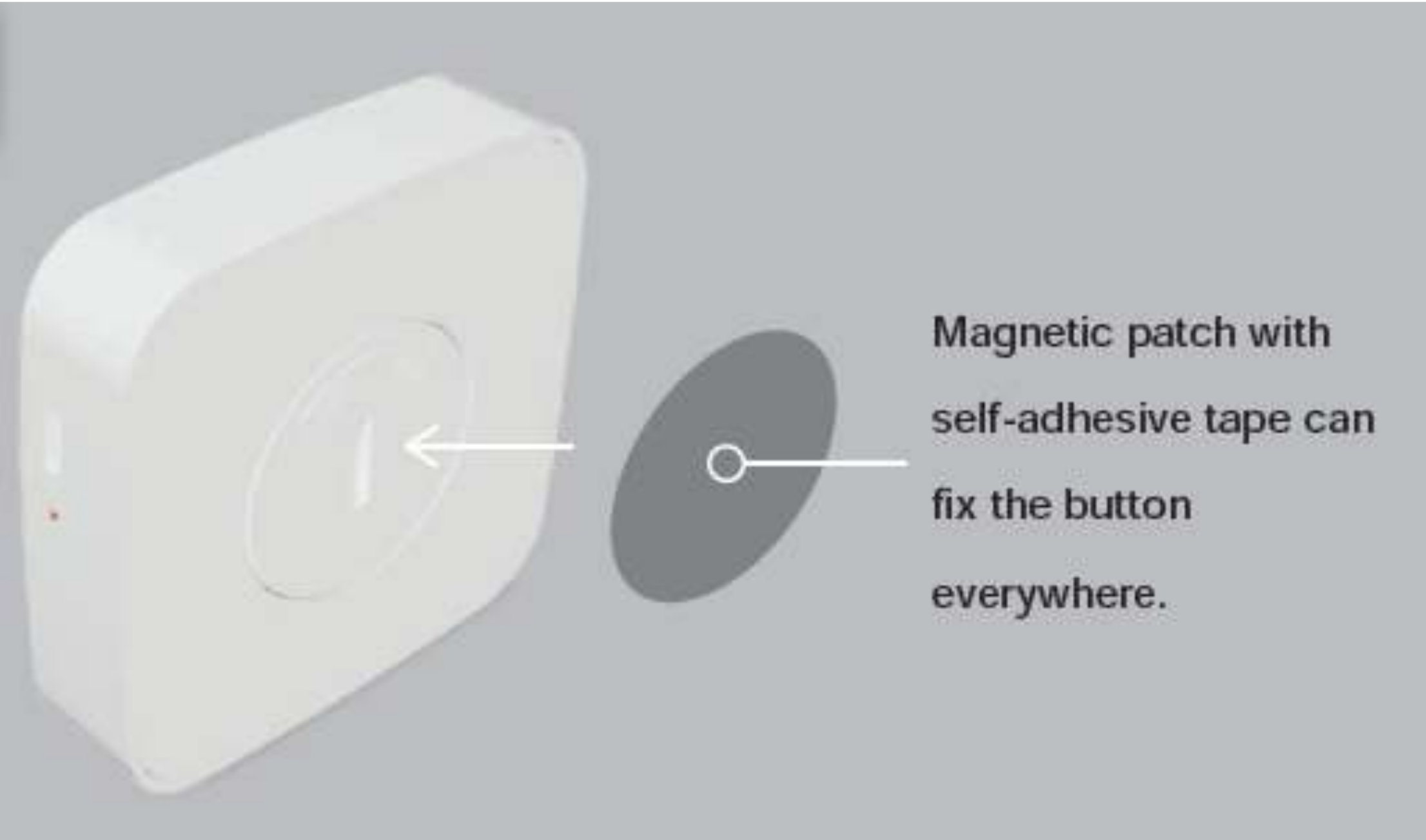

- 3 Programmable Gestures
- Smart Home For Everyone
- Controls All Tuya Devices

Model	Technology	Battery Type	Battery Life	Power Input	Signal Lights	Paring/ Reset	Working Temperature	Weight	Dimension (mm)
io-Pai-Ble	SIG Bluetooth Mesh	Rechargeable LIR2450 3.6V	4 Months, based on 20 uses per day. Recharge in 1-2 hours.	5V1A Micro USB	1 Red LED for Power Status 1 Blue LED for Bluetooth Status	Long press the button for 15 seconds until blue signal light flashes	0~45°C	32g without Battery	60*60*15

iO.e Button
is the
wireless
smart button that triggers
programmable actions
for all
Tuya-based
smart home devices.

The Wireless Smart Button has 1 button that enables 3 distinct gestures: **single tap, double tap, and long press.**

Each gesture triggers a set of **customizable actions.**
Each set of actions controls **multiple smart devices.**

The user may customize the set of actions in the smart app at any time.

For example—

When user returns home at night, the user may press the Button on the entrance counter to turn all lights and smart plugs in the home on. When the user leaves, a long tap turns all things off.

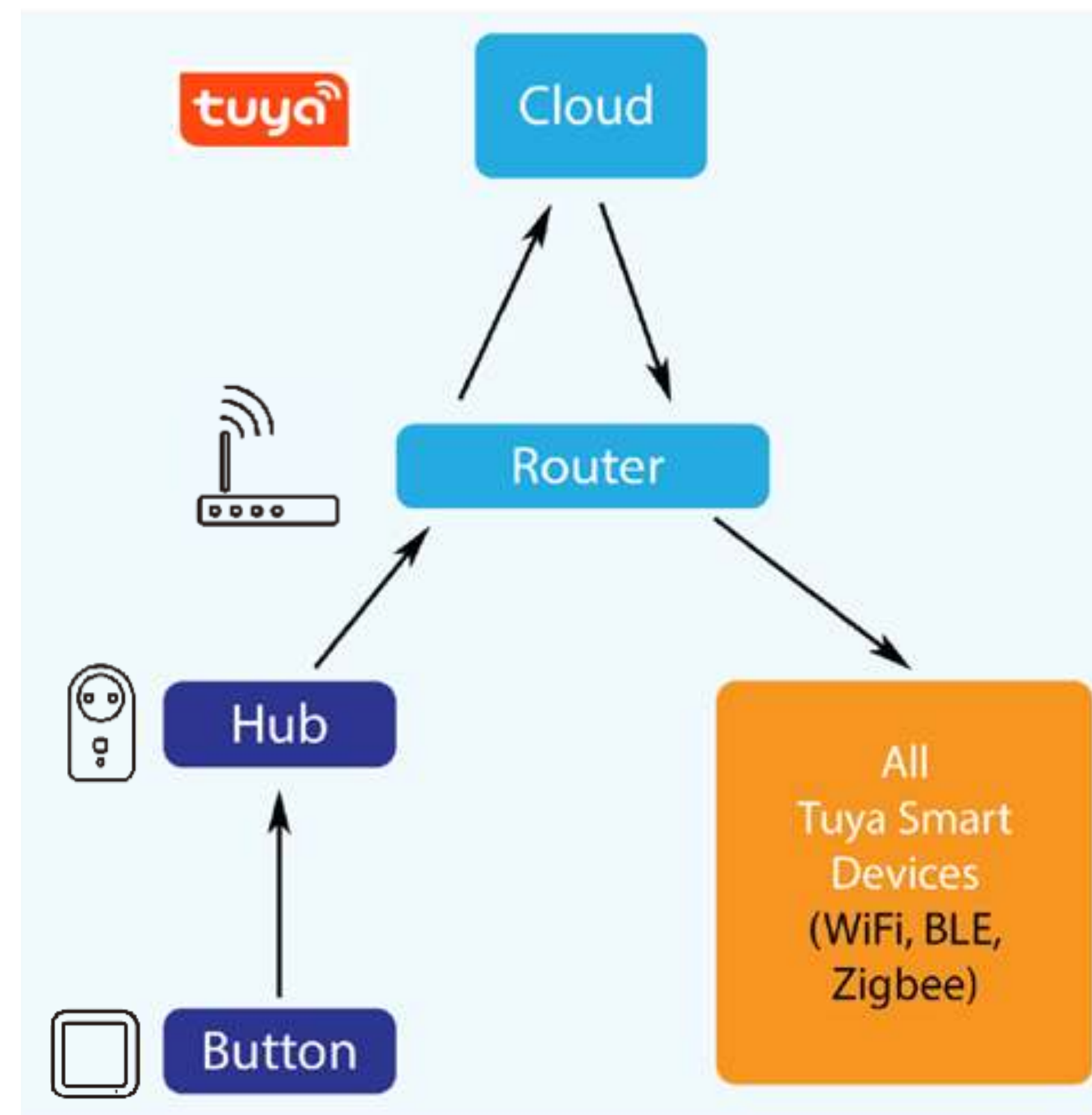



Smart Security Products

Powered by  tuya[®]



- Ideal for Home Security by Distance
- 3-in-1 Gateway, Hub, Night Light, and Siren
- Portable, Easy to Install & to Remove
- Quick Detection and High Reliability
- Expandable, Support up to 50 Wireless Devices
- Synergy
- Zigbee or Bluetooth Technology



Device	Power	Operating Conditions	Dimension (mm)	Description
Window/ Door Sensor	Battery Life Up to 12 Months	0-49°C	63.5*25.5*10	Detects opening and closing between 2 components and synergies with other smart devices.
Motion Sensor (PIR)	Battery Life Up to 12 Months	0-49°C	51*51*25.5	Detects movement and synergies with other smart devices. Sensitivity adjustable in smart APP.
Temperature & Humidity Sensor	Battery Life Up to 12 Months	0-49°C	43*43*12.7	Detects temperature and humidity in real time. Store data and display graph in APP. Smart automation can be set for temperature/humidity points
Siren Gateway	220-240V	0-49°C	89*89*38	Connects all smart sensors to Internet. Night light, gateway, and siren alarm 3-in-1. Smart arm/ disarm setting in APP.



io-DS01W



io-DS05W



io-DS07W

- Ideal for Home Security by Distance
- Portable, Easy to Install & to Remove
- Quick Detection and High Reliability
- Push Notification to APP



Model	Product Name	Description	Dimension (mm)
io-DS01W	Smart WiFi Door/Window Sensor	Detects open/close status of the door/window Battery: CR2 x 1 Standby time: 2 years Standby current: 13uA Wireless Type: 2.4GHz Protocol:IEEE 802.11b/g/n Wifi distance: 45m	71*21*22 (main body size) 40*11*11 (deputy body size)
io-DS05W	Smart WiFi Door/Window Sensor	Detects open/close status of the door/window Battery type: AA LR6 1.5V * 2PCS Stand by current: open: 28.4uA close: 28.1uA Trigger current: 43mA Pairing current: 37mA Working time: 4000 times Wireless Type: 2.4GHz Protocol:IEEE 802.11b/g/n Wifi distance: 45m	82*42*16 (main body size) 82*11*18 (deputy body size)
io-DS07W	Smart WiFi Door/Window Sensor	Detects open/close status of the door/window Anti-demolition function, push notification when device is removed Battery: CR123A 3V USB Power supply: 5V/1A Standby current: 27.9uA Wireless Type: 2.4GHz Protocol:IEEE 802.11b/g/n Wifi distance: 45m	82*27*23 (main body size) 50*13*16 (deputy body size)



Smart PIR Sensor



io-PD07W



io-PD01W



io-PD02W

- Ideal for Home Security by Distance
- Portable, Easy to Install & to Remove
- Quick Detection and High Reliability
- Push Notification to APP



Model	Product Name	Description	Dimension (mm)
io-PD07W	Smart WiFi PIR Sensor	Anti-demolition function, push notification when device is removed USB port power supply or Battery powered With temperature and humidity sensor Sensitive distance:12m Sensitive angle: 110° Battery: CR123A*2-3V USB Power supply: 5V/1A Standby current: 39.7uA	56*56*68
io-PD01W	Smart WiFi PIR Sensor	Measure the light sensitivity Sensitivity distance:7m Sensitive angle: 110° Battery: CR123A x 1 Standby time: 2 years Standby current:13uA	48*48*48
io-PD02W	Smart WiFi PIR Sensor	With magnet bracket Measure the light sensitivity Sensitivity distance:7m Sensitive angle: 110° Battery: CR123A x 1 Standby time: 2 years Standby current:13uA	48*48*48



Smart Smoke Alarm



- **Ideal for Home Security by Distance**
- **Portable, Easy to Install & to Remove**
- **Quick Detection and High Reliability**
- **Push Notification to APP**

Model	Product Name	Description	Dimension (mm)
io-GS558E-H04	Smart WiFi Smoke Alarm	Photoelectric chamber for early detection from all directions. Wireless smoke Alarm with heater function. Test button for easy recommended monthly testing. Low battery signal. Safety clip feature, not allow mounting without battery installed. DC 2X1.5V AA battery operated. Big Flash alarm indicator (red). Loud 90dB alarm signal Wireless distance: >50M	D120*H35.5



Smart Leakage Detector



Detects water leakage timely and notifies the smart APP. Works well with the siren alarm to create a nimble and smart alarm system.



- **Push Alert**
- **IP55**
- **Smart On-Off**
- **Long Standby Time**
- **Wi-Fi or Zigbee Technology**



Model	Product Name	Power	Standby Current	Working Temperature	Working Humidity	Dimension (mm)
io-zg-LDN	Smart Zigbee Leakage Detector	CR2 (3V)	1.1uA	0~40°C	20~85%	D69*H34



Smart Video Doorbell



- **145° wide viewing angle**
- **Two-way audio (full duplex)**
- **Motion zone detection**
- **Night visibility up to 10m**
- **Support mechanical/ wireless chime**
- **Support WebRTC**
- **Works with Echo Show and Google Chromecast**

Model	Camera	Video&Audio	Network	General
io-WiFi-DB8s	Image Sensor: 1/2.9" 2Megapixel CMOS Effective Pixels: 1920(H)*1080(V) Shutter: 1/25~1/100,000s Min. Illumination: Color 0.1Lux@F2.0, Black/White 0.01Lux@F2.0 IR Distance: Night visibility up to 10m Day/Night: Auto(ICR)/Color/ B/W WDR: DWDR Lens: 2.4mm@F2.0, 120°/64°/145°	Compression: H.264 Bit Rate: 32Kbps~2Mbps Frame Rate: 1~25fps Audio Input/Output: Bulit-in mic/speaker	Alarm Trigger: Button triggering, motion detection Wireless Security: 64/128-bit WPA/WPA2, WPA-PSK/WPA2-PSK, WPS Communication Protocol: HTTP, DHCP, DNS, TCP/IP, RTSP Interface Protocol: Private Wireless: 2.4G WIFI(IEEE802.11b/g/n) Mobile Phone OS: iOS 9 or later, Android 5 or later Security: AES128 Max. User Access: 6	Operating Temperature: -20 °C to 50 °C IP Rating: IP53 Power Supply: AC12~24V, DC 5V/1A Storage: SD card(Max.128G), Cloud storage Dimensions: 115x45x28mm Weight: 90g



Smart Camera



- **IP65 weatherproof**
- **Two-way audio (full duplex)**
- **Motion zone selection**
- **Night visibility up to 10m**
- **Support WebRTC**
- **Works with Echo Show and Google Chromecast**



Model	Camera	Video&Audio	Network	General
io-bullet2s	Image Sensor: 1/2.9" 2Megapixel CMOS Effective Pixels: 1920(H)*1080(V) Shutter: 1/20~1/10,000s Min. Illumination: Color 0.1Lux@F2.0, Black/White 0.01Lux@F2.0 IR Distance: Night visibility up to 10m Day/Night: Auto(ICR)/Color/ B/W WDR: DWDR Lens: 4.0mm@F2.0, 85°/46°/100°	Compression: H.264 Bit Rate: 32Kbps~2Mbps Frame Rate: 1~25fps Dual Stream: Yes Audio Input/Output: Bulit-in mic/speaker	Alarm Trigger: Intelligent motion detection Wireless Security: 64/128-bit WPA/WPA2, WPA-PSK/WPA2-PSK, WPS Communication Protocol: HTTP, DHCP, DNS, TCP/IP, RTSP Interface Protocol: Private Wireless: 2.4G WIFI(IEEE802.11b/g/n) Mobile Phone OS: iOS 9 or later, Android 5 or later Security: AES128 Max. User Access: 6	Operating Temperature: -20 °C to 50 °C IP Rating: IP65 Power Supply: DC 12V/1A Storage: SD card(Max.128G), Cloud storage, NVR Dimensions: 80x80x132mm Weight: 170g



Smart Camera



- Intelligent motion/sound detection
- Two-way audio (half duplex)
- Motion zone selection
- Night visibility up to 10m
- Support WebRTC
- Works with Echo Show and Google Chromecast



Model	Camera	Video&Audio	Network	General
io-mini20s	Image Sensor: 1/2.9" 2Megapixel CMOS Effective Pixels: 1920(H)*1080(V) Shutter: 1/20~1/10,000s Min. Illumination: Color 0.1Lux@F2.0, Black/White 0.01Lux@F2.0 IR Distance: Night visibility up to 10m Day/Night: Auto(ICR)/Color/ B/W WDR: DWDR Lens: 3.6mm@F2.0, 85°/46°/100°	Compression: H.264 Bit Rate: 32Kbps~2Mbps Frame Rate: 1~25fps Dual Stream: Yes Audio Input/Output: Bulit-in mic/speaker	Alarm Trigger: Intelligent motion/ sound detection Wireless Security: 64/128-bit WPA/WPA2, WPA-PSK/WPA2-PSK, WPS Communication Protocol: HTTP, DHCP, DNS, TCP/IP, RTSP Interface Protocol: Private Wireless: 2.4G WIFI(IEEE802.11b/g/n) Mobile Phone OS: iOS 9 or later, Android 5 or later Security: AES128 Max. User Access: 6	Operating Temperature: -20 °C to 50 °C Power Supply: DC 5V/1A Storage: SD card(Max.128G), Cloud storage, NVR Dimensions: 60x58x110mm Weight: 76g



Smart Camera



- Auto tracking
- Intelligent motion/sound detection
- Two-way audio (half duplex)
- Motion zone selection
- Night visibility up to 10m
- Support WebRTC
- Works with Echo Show and Google Chromecast

Model	Camera	Video&Audio	Network	General
io-speed17t	Image Sensor: 1/2.8" 3Megapixel CMOS Effective Pixels: 2304(H)*1296(V) Shutter: 1/20~1/10,000s Min. Illumination: Color 0.1Lux@F2.0, Black/White 0.01Lux@F2.0 IR Distance: Night visibility up to 10m Day/Night: Auto(ICR)/Color/ B/W WDR: DWDR Lens: 3.6mm@F2.0, 85°/46°/100°	Compression: H.264 Bit Rate: 32Kbps~2Mbps Frame Rate: 1~25fps Dual Stream: Yes Audio Input/Output: Bulit-in mic/speaker	Alarm Trigger: Intelligent motion/ sound detection Wireless Security: 64/128-bit WPA/WPA2, WPA-PSK/WPA2-PSK, WPS Communication Protocol: HTTP, DHCP, DNS, TCP/IP, RTSP Interface Protocol: Private Wireless: 2.4G WIFI(IEEE802.11b/g/n) Mobile Phone OS: iOS 9 or later, Android 5 or later Security: AES128 Max. User Access: 6	Pan/Tilt: Pan: 0°~350°, tilt: -15°~40° Operating Temperature: -20 °C to 50 °C Power Supply: DC 5V/1A Storage: SD card(Max.128G), Cloud storage, NVR Dimensions: 73x78x121mm Weight: 170g



Smart Floodlight Camera



io-IPlight-d



io-IPlight-s

- **PIR Human Detection**
- **Motion zone selection**
- **Night visibility up to 10m**
- **Siren Alarm**
- **IP65 weatherproof**
- **Works with Echo Show and Google Chromecast**

Model	Camera	Video&Audio	Light&PIR	General
io-IPlight-d	Image Sensor: 1/2.9" 2Megapixel CMOS Effective Pixels: 1920(H)*1080(V) Min. Illumination: Color 0.1Lux@F2.0, Black/White 0.01Lux@F2.0 IR Distance: Night visibility up to 10m Day/Night: Auto(ICR)/Color/ B/W WDR: DWDR Lens: 2.8mm@F2.0, 98°/53°/120°	Compression: H.264 Bit Rate: 32Kbps~2Mbps Frame Rate: 1~25fps Audio Input/Output: Bulit-in mic/speaker Siren Alarm: 120dB Alarm Trigger: PIR detection	Lamp Power: 25W Luminous Flux: 2000lm Color Temperature: 6500K Light Control: Manually/ PIR detection/ Schedule PIR Detection Range: 12m, 120°	Operating Temperature: -20 °C to 50 °C Power Supply: AC 100-240V Power Consumption: Max. 32W Storage: SD card(Max.128G), Cloud storage, NVR Dimensions: 151x277x132mm Weight: 640g
io-IPlight-s	Image Sensor: 1/2.9" 2Megapixel CMOS Effective Pixels: 1920(H)*1080(V) Min. Illumination: Color 0.1Lux@F2.0, Black/White 0.01Lux@F2.0 IR Distance: Night visibility up to 10m Day/Night: Auto(ICR)/Color/ B/W WDR: DWDR Lens: 3.2mm@F2.0, 106°/57°/130°	Compression: H.264 Bit Rate: 32Kbps~2Mbps Frame Rate: 1~25fps Audio Input/Output: Bulit-in mic/speaker Siren Alarm: 100dB Alarm Trigger: PIR detection	Lamp Power: 12W Luminous Flux: 1000lm Color Temperature: 3200K Light Control: Manually/ PIR detection/ Schedule PIR Detection Range: 10m, 120°	Pan: 0°-120° Operating Temperature: -20 °C to 50 °C Power Supply: AC 100-240V Power Consumption: Max. 20W Storage: SD card(Max.128G), Cloud storage, NVR Dimensions: 74x131x260mm Weight: 800g



Smart Zigbee Radiator Valve

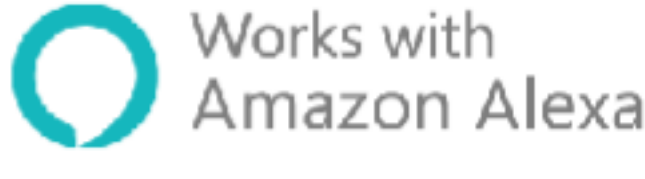
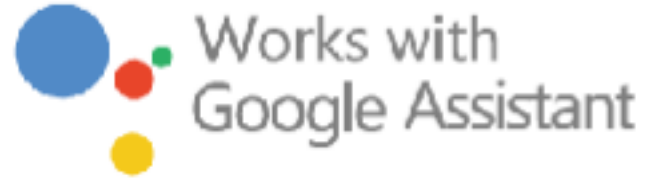

- **Smart Control**
- **Reliable Detection**
- **Open Window Function**
- **Anti-freezing Function**
- **Child Lock Function**
- **Energy Saving**
- **Programmable Mode**



*Zigbee Gateway Required

Model	Power	Ambient Temperature	Transportation Temperature	Accuracy	Dimension (mm)	Display
io-Zb-RV-s	2 AA Battery	0~50°C	-10~60°C	0.5°C	D55*L92	LED



Smart Bluetooth Radiator Valve

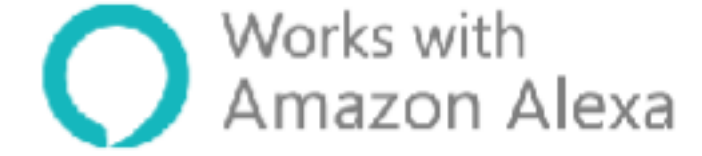

- **Smart Control**
- **Reliable Detection**
- **Open Window Function**
- **Anti-freezing Function**
- **Child Lock Function**
- **Energy Saving**
- **Programmable Mode**



*SIG Bluetooth Gateway Required

Model	Power	Ambient Temperature	Transportation Temperature	Accuracy	Dimension (mm)	Display
io-BLE-RV-s	2 AA Battery	0~50°C	-10~60°C	0.5°C	D55*L92	LED

Bluetooth or Zigbee?

- The functions are the same.



- Suitable for smaller places: $\leq 10\text{m}$ wireless transmit range at open distance.
- Suitable for customers who already have Tuya SIG Bluetooth devices.
- Suitable for unstable Wi-Fi conditions: can be used via Bluetooth direct connection.
- Two kinds of gateways available: SIG Bluetooth gateway and Smart Gateway Plug.

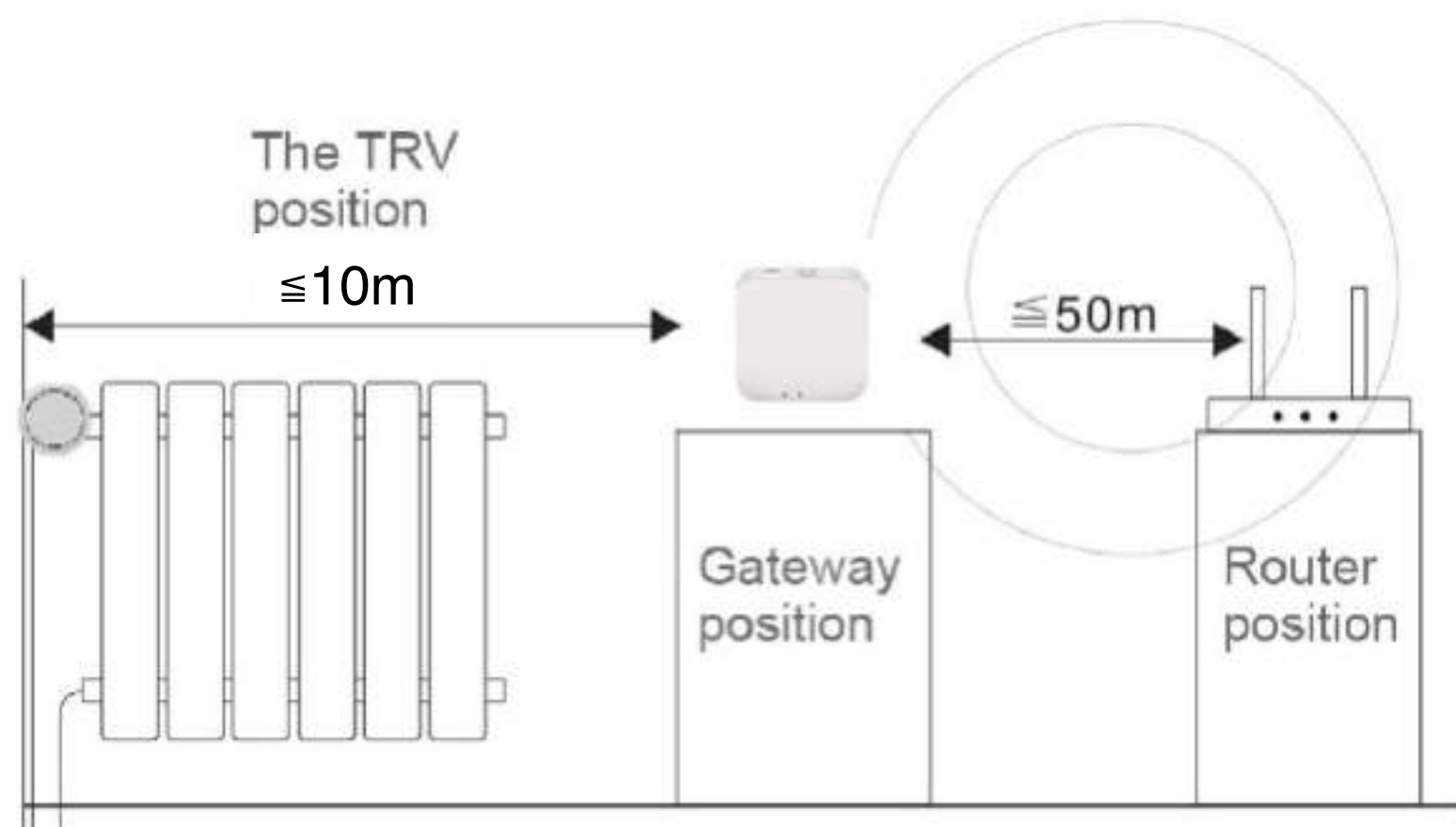

- Suitable for bigger places: $\leq 30\text{m}$ wireless transmit range at open distance.
- Suitable for customers who already have Tuya Zigbee devices.

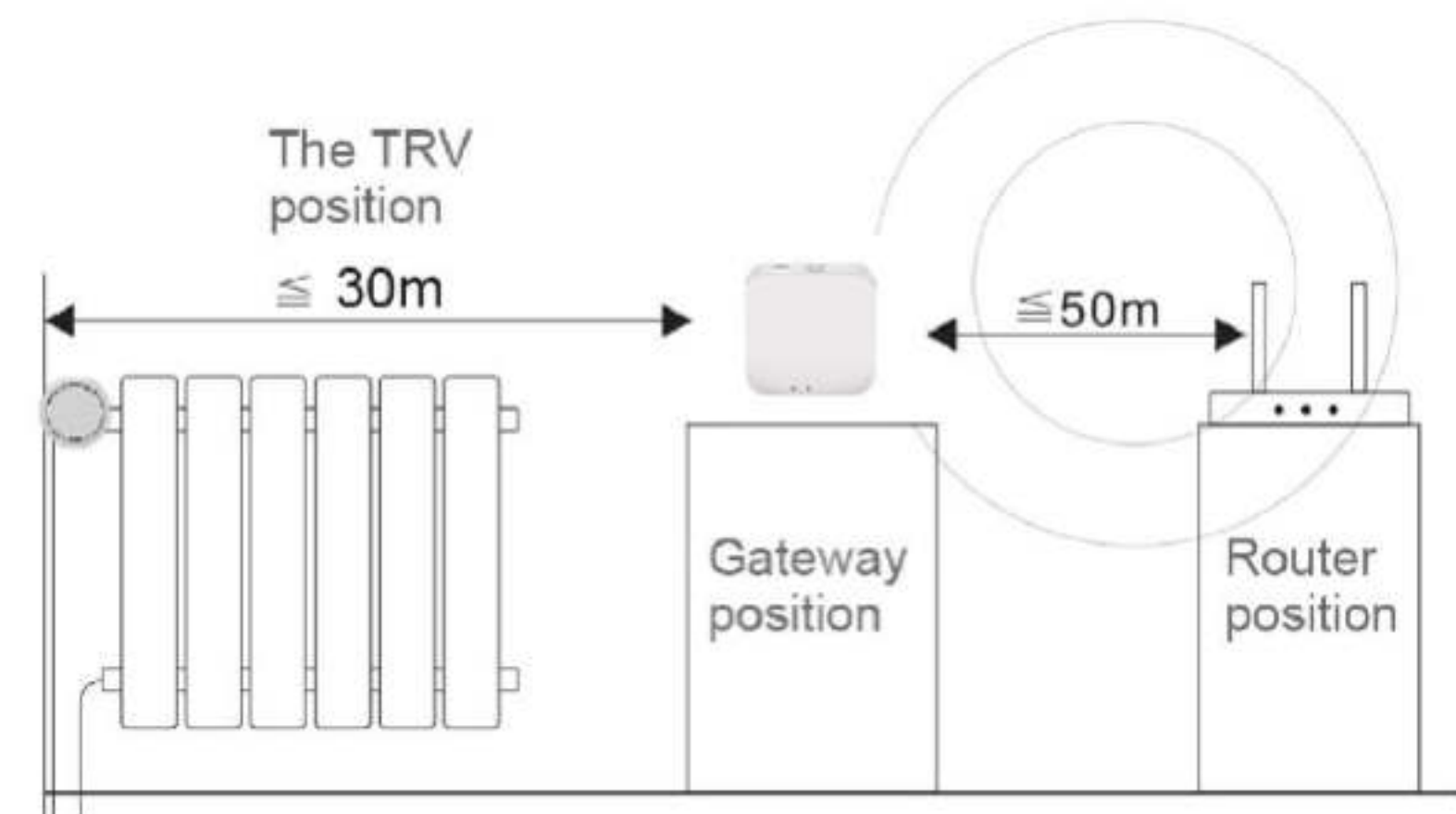



Smart Home Starter Kit

Powered by  tuya[®]

Smart Home Starter Kit

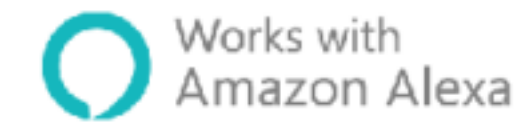

Our smart home starter kit contains 3 smart bulbs, a built-in gateway plug, and our patented smart button.

- **Bluetooth Technology**



- **Essential Items**



- **Inexpensive**

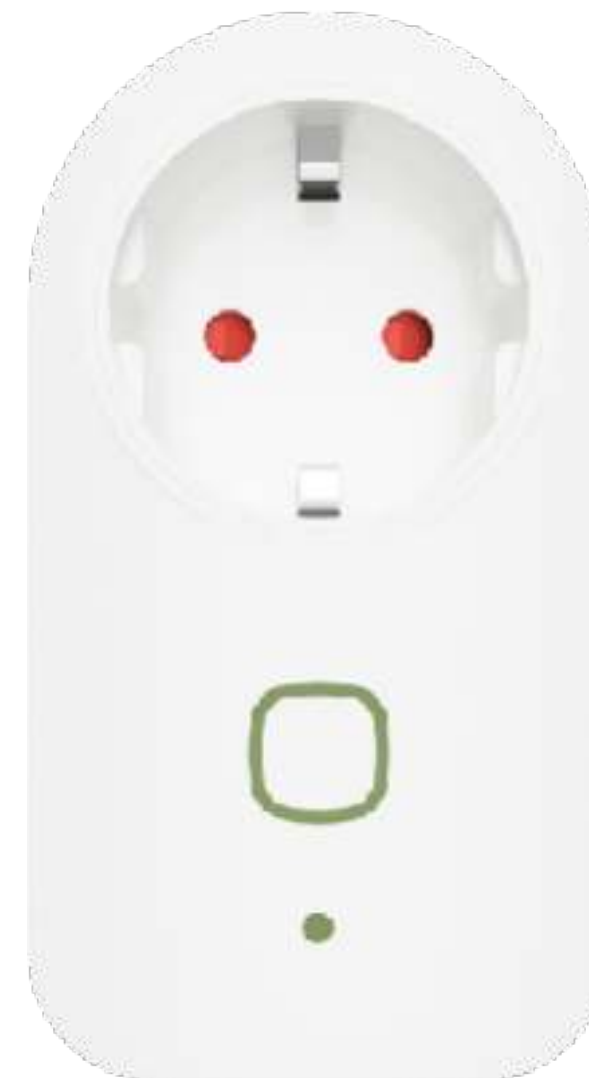

- **Made for Everyone**



io.e

Introducing the Kit

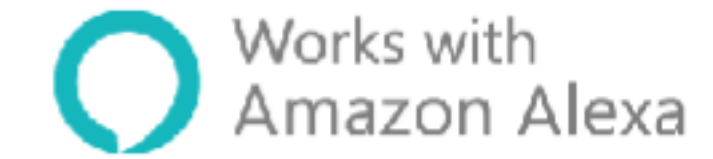

RED CE



- All-in-one Smart Home for Everyone
- Built-in SIG Bluetooth Gateway Plug
- Power Meter Function on Plug
- Smart Button Directly Controls the Bulbs

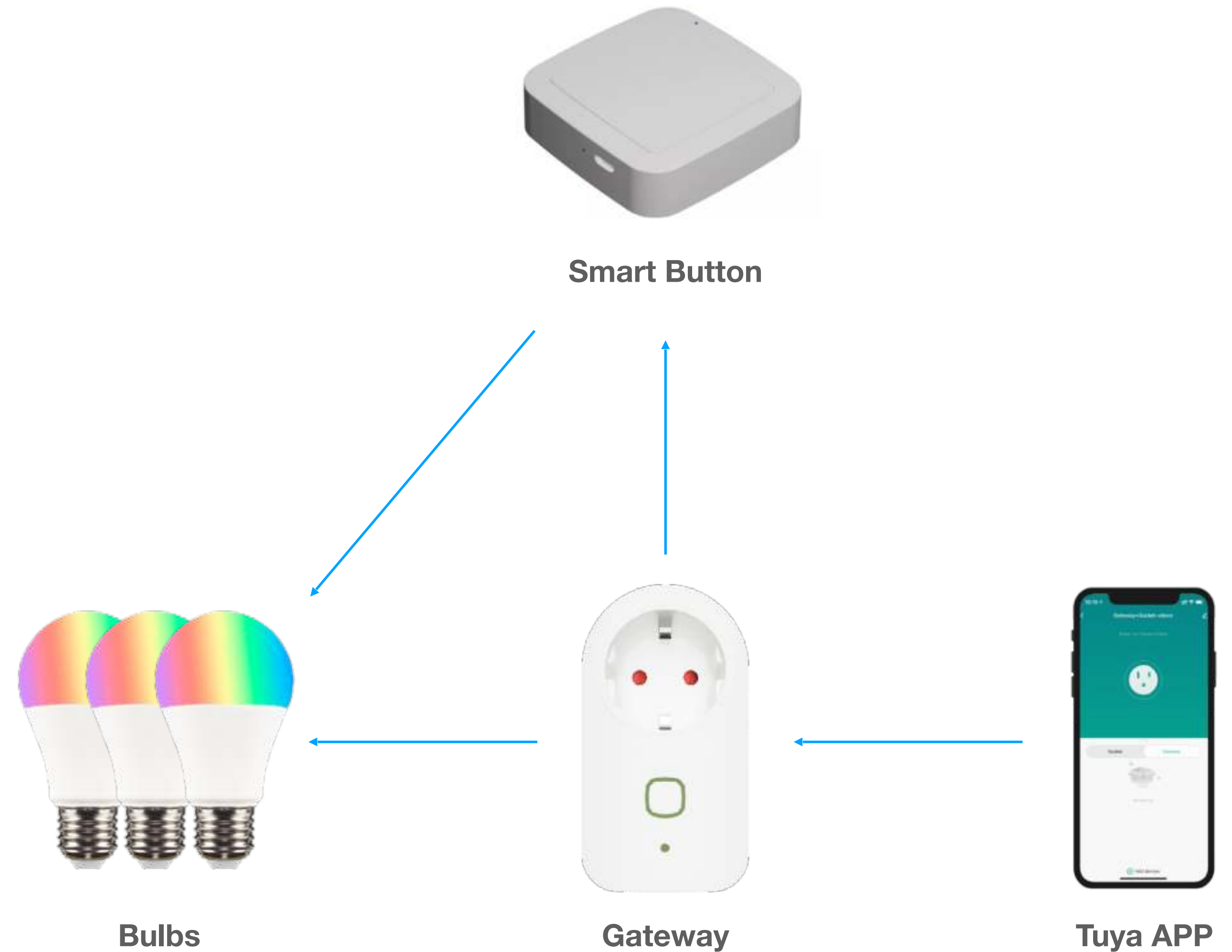



Smart Bluetooth Mesh Bulb

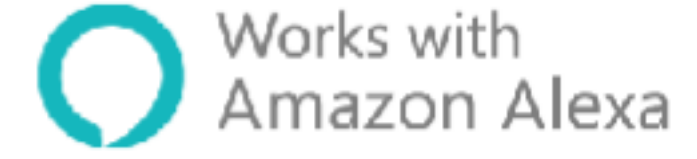

- **CCT + Color Control**
- **Smart Control**
- **Extended Range**



Model	Input Voltage	Power	Efficacy	CCT	Dimmable	Lifespan	CRI	Dimension (mm)
io-Blem60	220-240V	9W	80lm/W	RGB-CW	Brightness+CCT	15000H	80	D60*H110



Smart Gateway Plug



- Works the Same as the WiFi Plug with Built-in SIG Bluetooth Hub
- Can Link More Than 30 Tuya Bluetooth Devices
- IP44 Version Can be Used Outdoor
- Power Meter Function

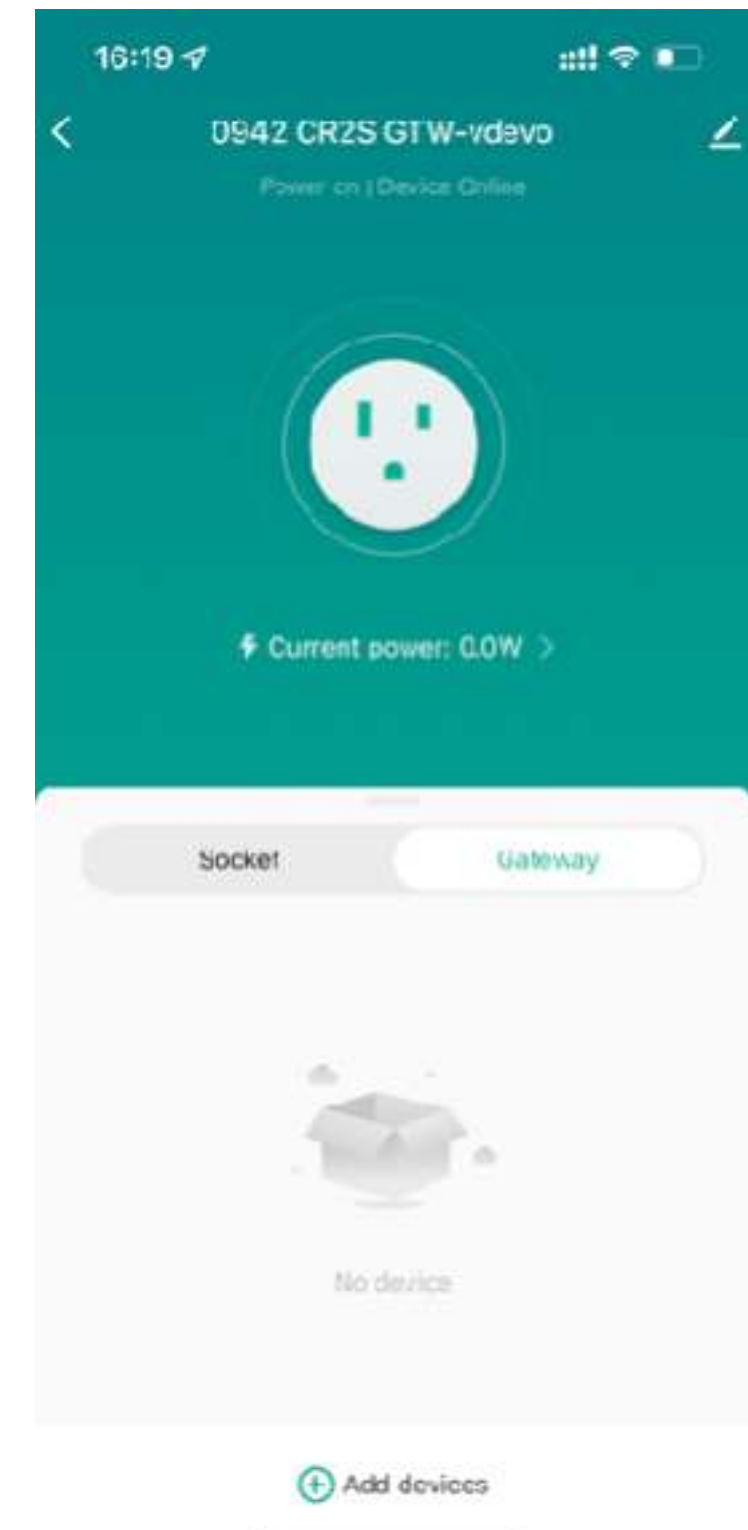
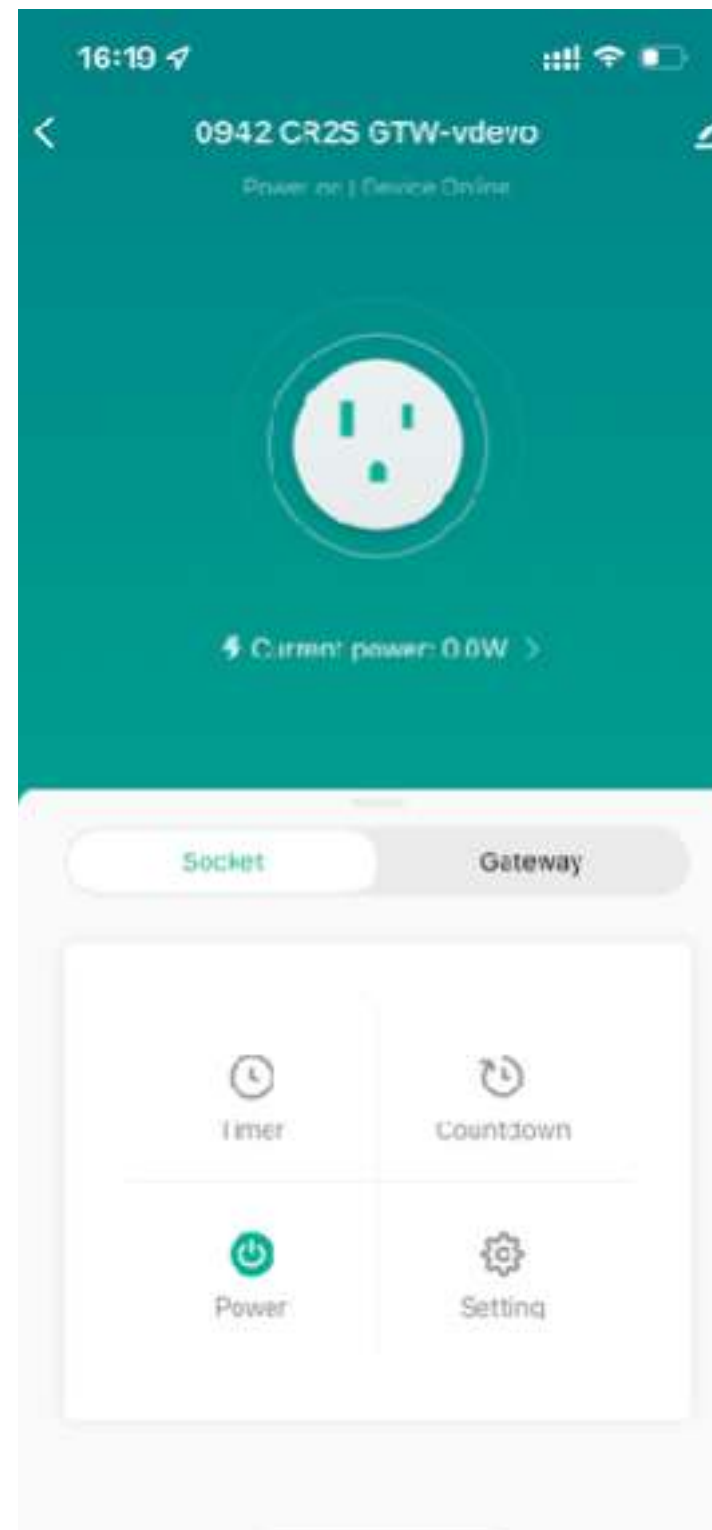

Model	Input Voltage	Max Power	Max Current	IP Rating	Power Meter Function	Dimension (mm)
io-WiFi-PlugHub	230V	3680W	16A	IP 20	Yes	L54*W78*H101
io-WiFi-PlugHub-IP44	230V	3680W	16A	IP 44	Yes	L58*W90*H115



Smart Button



● Patented



- 3 Programmable Gestures
- Smart Home For Everyone
- Controls All Tuya Devices

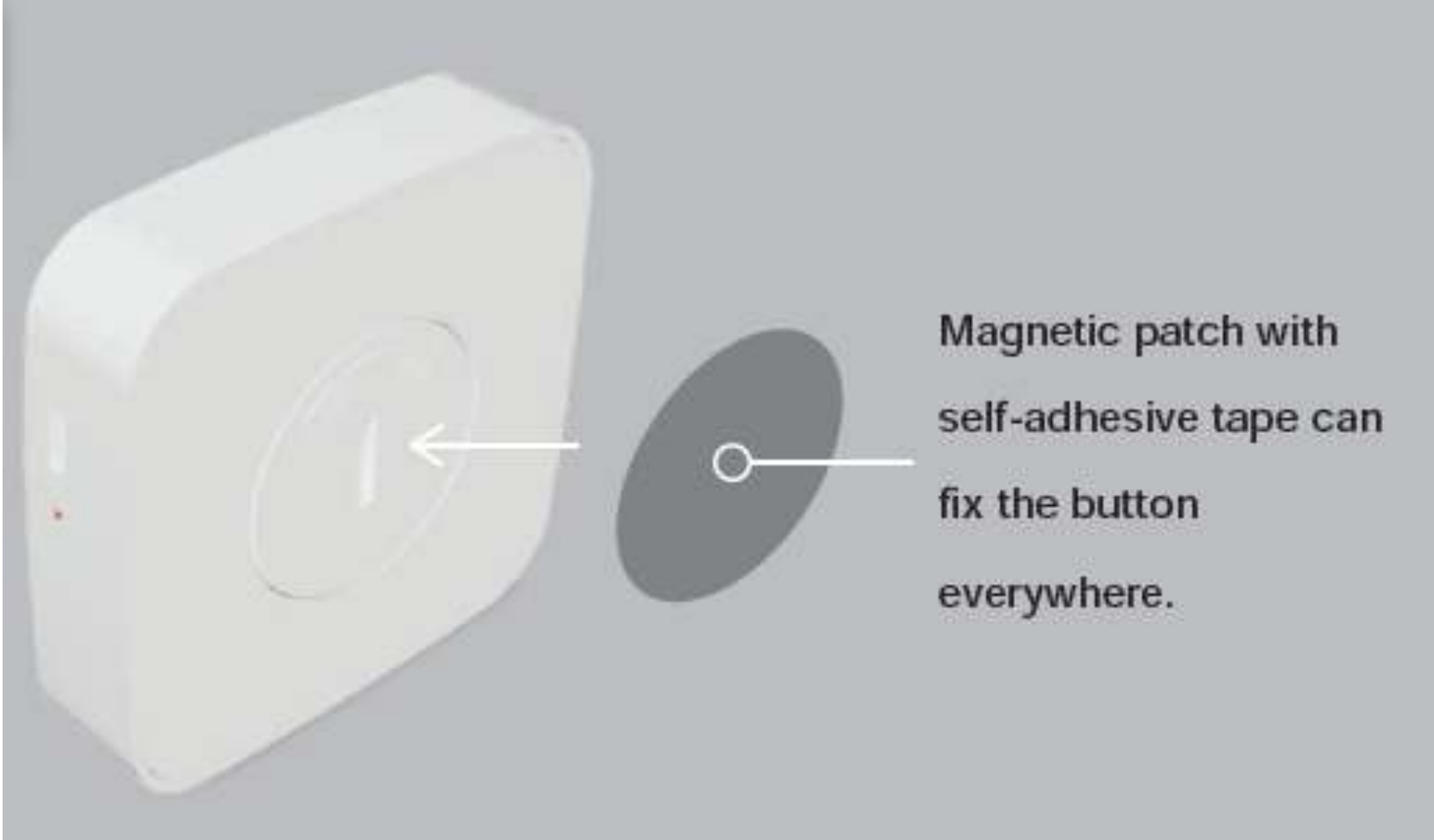

Model	Technology	Battery Type	Battery Life	Power Input	Signal Lights	Paring/ Reset	Working Temperature	Weight	Dimension (mm)
io-Pai-Ble	SIG Bluetooth Mesh	Rechargeable LIR2450 3.6V	4 Months, based on 20 uses per day. Recharge in 1-2 hours.	5V1A Micro USB	1 Red LED for Power Status 1 Blue LED for Bluetooth Status	Long press the button for 15 seconds until blue signal light flashes	0~45°C	32g without Battery	60*60*15



HANGZHOU HEMOS LIGHTING COMPANY LIMITED

301, Building 27, Xixi Yihao Business Center, No.808 Wener West Road, Hangzhou, Zhejiang, China

www.ioucys.com info@ioucys.com

Factory: Chenhui Industrial Zone, Shangyu District, Shaoxing, Zhejiang, China